

2013

**CARPHA  
LABORATORY  
USER MANUAL**





# CARPHA Laboratory Procedure Manual

Section: QSE 05 – Process Control

Title: Laboratory User Manual

Doc. No: GUL-Q05-001

Page 1 of 58

Effective date: 01.07.2013

Review date: 01.07.2014

Edition: 1

## **TABLE OF CONTENTS**

PREFACE	2
LOCATION AND CONTACT INFORMATION	3
LABORATORY BUSINESS SCHEDULE	4
AREAS OF TECHNICAL COOPERATION AND CORE PROGRAMMES	5
SUBMISSION OF SPECIMENS TO CARPHA	6
TRANSPORTATION OF SPECIMENS	6
SAMPLE LABORATORY INVESTIGATION FORM	7
INFORMATION REQUIRED FOR ALL SPECIMENS SUBMITTED TO CARPHA	8
SPECIMEN REJECTION CRITERIA	9
LABORATORY TESTING SERVICES	10
ENTOMOLOGY SPECIMEN REFERRALS	15

### **ANNEX 1**

SYNDROME CASE DEFINITION AND DIAGNOSIS FLOWCHARTS	16
---	----

### **ANNEX 2**

SPECIMEN COLLECTION GUIDELINES	19
- BLOOD	20
- RESPIRATORY TRACT	27
- CEREBROSPINAL FLUID	31
- FAECAL	32
- EYE	34
- SKIN LESIONS	36
- URINE	39
- POSTMORTEM TISSUE	41
- TB SPECIMENS	44

### **ANNEX 3**

GUIDELINES FOR PREPARATION, PACKING AND SHIPPING SPECIMENS	46
- CATEGORIZATION OF INFECTIOUS SUBSTANCES	48
- PACKAGING AND SHIPPING INSTRUCTIONS	50



## CARPHA Laboratory Procedure Manual

Section: QSE 05 – Process Control

Title: Laboratory User Manual

Doc. No: GUL-Q05-001

Page 2 of 58

Effective date: 01.07.2013

Review date: 01.07.2014

Edition: 1

### PREFACE

Dear Colleague,

Thank you for your interest in accessing CARPHA's laboratory services.

CARPHA is the amalgamation of five Caribbean regional health institutions which started operation from the 01<sup>st</sup> January, 2013. The RHI's are: **Caribbean Epidemiology Centre (CAREC)**, the **Caribbean Environmental Health Institute (CEHI)**, the **Caribbean Food and Nutrition Institute (CFNI)**, the **Caribbean Health Research Centre (CHRC)** and the **Caribbean Regional Drug Testing Laboratory (CRDTL)**. For more info, please feel free to visit CARPHA's website <http://www.carpha.org>

### CARPHA's Mission

To provide strategic direction, in analyzing, defining and responding to public health priorities of CARICOM, in order to prevent disease, promote health and to respond to public health emergencies.

To support solidarity in health, as one of the principal pillars of functional cooperation, in the Caribbean Community.

### CARPHA's Vision

A Caribbean in which the health of the people, is promoted and protected from disease, injury and disability, thereby fostering the wellness revolution promoted by the Port of Spain Declaration\*.

The main function of the laboratory based in Trinidad is to provide reference and referral services, training, technology transfer, monitoring and research of public health importance.

Our staff is committed to providing the highest quality service to our member countries and as such we have instituted and continually upgraded our systems to ensure that the quality of our services is assured at all times.

We hope that this guide will provide the necessary information to facilitate access to our services.

We welcome the opportunity to serve you and are happy to receive your comments.

### PURPOSE OF THE DOCUMENT

The purpose of this document is to provide general information about pathogens under regional surveillance, clinical specimen collection and transportation guidelines for use by health care providers and public health professionals in CARPHA member countries.



## CARPHA Laboratory Procedure Manual

Section: QSE 05 – Process Control

Title: Laboratory User Manual

Doc. No: GUL-Q05-001

Page 3 of 58

Effective date: 01.07.2013

Review date: 01.07.2014

Edition: 1

### **LOCATION AND CONTACT INFORMATION**

The CARPHA laboratory is located at:

16-18 Jamaica Boulevard,  
Federation Park,  
Port-of-Spain, TRINIDAD

Telephone: 1-868-622-4261  
Fax: 1-868-622-2792  
e-mail address customerservice@carpha.org  
PBX 1-868-622-4261/2

### **LABORATORY CONTACT INFORMATION**

#### **Data Entry and Reporting:**

Fax Number 1-868-628-9302

#### **Laboratory Administration:**

Telephone Number 1-868-628-1032

Fax Number 1-868-628-9311



**CARPHA Laboratory Procedure Manual**

**Section: QSE 05 – Process Control**

**Title: Laboratory User Manual**

**Doc. No: GUL-Q05-001**

**Page 4 of 58**

**Effective date: 01.07.2013**

**Review date: 01.07.2014**

**Edition: 1**

**LABORATORY BUSINESS SCHEDULE**

The routine operation hours for the laboratory are Monday to Friday 8:00 a.m. to 4:30 p.m.

For outside of routine working hours, weekends, public holidays and emergency situations please contact CARPHA at 1-868-622-4261/2 and 1-868-299-0895.

The declared public holidays in Trinidad and Tobago are as follows:

<b>MONTH</b>	<b>DAY</b>	<b>HOLIDAY</b>
<b>January</b>	<b>01</b>	<b>New Year's Day</b>
<b>March</b>	<b>30</b>	<b>Shouter Baptist Liberation Day</b>
<b>May</b>	<b>30</b>	<b>Indian Arrival Day</b>
<b>June</b>	<b>19</b>	<b>Corpus Christi</b>
<b>August</b>	<b>01</b> <b>31</b>	<b>Emancipation Day</b> <b>Independence Day</b>
<b>September</b>	<b>24</b>	<b>Republic Day</b>
<b>December</b>	<b>25</b> <b>26</b>	<b>Christmas Day</b> <b>Boxing Day</b>
<b>Dates to be announced</b>	<b>Change from year to year</b>	<b>Good Friday</b> <b>Easter Monday</b> <b>Labour Day</b> <b>Eid-ul-Fitr</b> <b>Divali</b>



## CARPHA Laboratory Procedure Manual

Section: QSE 05 – Process Control

Title: Laboratory User Manual

Doc. No: GUL-Q05-001

Page 5 of 58

Effective date: 01.07.2013

Review date: 01.07.2014

Edition: 1

### AREAS OF TECHNICAL COOPERATION AND CORE PROGRAMMES

Surveillance system strengthening involves providing technical cooperation to CARPHA member countries to support and enhance their capacity in the areas of surveillance and risk assessment for communicable diseases, including air borne, food and water borne, sexually transmitted, vector borne and vaccine preventable diseases; surveillance of non-communicable diseases and their risk factors, injuries and violence; preparation and response to disasters, emergencies and special situations as it pertains to surveillance; and outbreak investigations. Surveillance is promoted as the mechanism that public health agencies should use to monitor the health of their communities. The work of the Agency encompasses strengthening all aspects of surveillance, namely data collection, collation, validation, analysis and interpretation; laboratory support for surveillance; and the production and use of timely information for planning, implementation and evaluation of public health practice.

The main role of the CARPHA laboratory is to support surveillance activities and strengthen laboratories in countries. However, it is recognized that some countries (especially those with smaller populations) have limited laboratory testing capacity; and to such countries CARPHA will provide primary testing services. One of the laboratory's focus is the transfer of technology in order to facilitate the acquisition of the highest testing capacity that can be achieved in each country. It is recognized that this capacity varies between countries.

The areas of focus are strengthening sub-regional and national capacities in integrated communicable disease surveillance for the following:

- Syndromes
- Airborne diseases
- Food and water borne diseases
- Sexually transmitted diseases, including HIV/AIDS
- Vaccine preventable diseases
- Vector borne diseases
- Other diseases, including selected neglected diseases
- Antimicrobial resistance

Note: See Annex 1 for list of diseases, case definitions and algorithms in each category



## CARPHA Laboratory Procedure Manual

Section: QSE 05 – Process Control

Title: Laboratory User Manual

Doc. No: GUL-Q05-001

Page 6 of 58

Effective date: 01.07.2013

Review date: 01.07.2014

Edition: 1

### **SUBMISSION OF SPECIMENS TO CARPHA**

Specimens must be routed through the relevant National Reference/ Public Health Laboratory or the Ministry of Health.

The following minimum information must accompany each specimen

1. **A labelled specimen container with the following information:**
  - National Patient ID/Laboratory Number
  - Date of collection
  - Specimen type
2. **Completed CARPHA Laboratory Investigation form (Refer to page. 8) or Country's Laboratory form with similar information**

### **GENERAL INFORMATION FOR TRANSPORTATION OF SPECIMENS**

***Referred specimens must always be prepared, packaged and transported in accordance with current international shipping guidelines and IATA (International Air Transport Association) regulations.***

1. Incoming Receipt Notifications (including baggage tags, airway bill number) should be sent to the Laboratory using the following means of communication –

Data Entry and Reporting Unit

Fax: 1-868-628-9302,

Ph: 1-868-622-4261/2

Email: [customerservice@carpha.org](mailto:customerservice@carpha.org)

2. All packages must be addressed in the following manner:

**The Director of CARPHA  
The Caribbean Public Health Agency (CARPHA)  
16-18 Jamaica Boulevard  
Federation Park  
PORT of SPAIN  
TRINIDAD, W.I.**



**CARPHA Laboratory Procedure Manual**

**Section: QSE 05 – Process Control**

**Title: Laboratory User Manual**

**Doc. No: GUL-Q05-001**

**Page 7 of 58**

**Effective date: 01.07.2013**

**Review date: 01.07.2014**

**Edition: 1**

**INSERT SAMPLE LABORATORY INVESTIGATION FORM** (Sent as separate word document)



**CARPHA Laboratory Procedure Manual**

Section: QSE 05 – Process Control

Title: Laboratory User Manual

Doc. No: GUL-Q05-001

Page 8 of 58

Effective date: 01.07.2013

Review date: 01.07.2014

Edition: 1

**INFORMATION REQUIRED FOR ALL SPECIMENS SUBMITTED TO CARPHA**

Indicate the following details on the CARPHA Laboratory Investigation form (Page 7):

SECTION	ESSENTIAL INFORMATION
1. Patient Information	- Patient demographics e.g. National Patient ID and/or Laboratory Number, Age, D.O.B., Sex, Address, Occupation (where relevant)
2. Referring Doctor	- Name of Referral Doctor/ Hospital with contact information
3. Provisional Diagnosis, Additional Notes	- Clinical diagnosis - Travel history
4. Food/Animal/Environment Sample Details	- Specimen type
5. Case	- Type of case e.g. Single/Outbreak/Survey
6. Date of Onset of Illness	- Date of onset of illness
7. Outcome	- Hospitalization status or death
8. Signs and Symptoms	Clinical signs and symptoms
9. Syndromic Classification	
10. Immunization History	When applicable - travel history; vaccination history/status
Laboratory Use and Physician/EHO Use	- LABORATORY INVESTIGATION(S) requested - Date of collection of specimen(s) - Laboratory results of all tests performed in country re that specimen, including date tested - Date specimen referred to CARPHA for testing



## CARPHA Laboratory Procedure Manual

Section: QSE 05 – Process Control

Title: Laboratory User Manual

Doc. No: GUL-Q05-001

Page 9 of 58

Effective date: 01.07.2013

Review date: 01.07.2014

Edition: 1

Specimens may be rejected based upon the following criteria however this decision will be made on a case by case basis and the submitting agency will be notified

SPECIMEN REJECTION CRITERIA	FURTHER ACTION
<ul style="list-style-type: none"><li>Unlabelled or mislabelled specimen</li></ul>	<ul style="list-style-type: none"><li>Submitting agency will be notified that specimen will be discarded</li></ul>
<ul style="list-style-type: none"><li>Specimens with insufficient volume</li><li>Specimen deemed not to be of an acceptable quality for processing at CARPHA</li></ul>	<ul style="list-style-type: none"><li>Submitting agency will be notified and new specimens will be requested by CARPHA</li><li>Submitting agency will be notified and specimen will be discarded</li></ul>
Specimens without the following information: <ul style="list-style-type: none"><li>Clinical diagnosis and/or signs and symptoms</li><li>Date of onset of symptoms</li><li>Date of specimen collection</li></ul>	<ul style="list-style-type: none"><li>The submitting agency will receive notification requesting the required information prior to testing.</li><li>Specimens will be appropriately stored awaiting the requested information</li></ul>
<ul style="list-style-type: none"><li>Illegible patient documentation.</li></ul>	<ul style="list-style-type: none"><li>A request for clarification of information will be sent to the submitting agency for urgent resolution</li></ul>
<ul style="list-style-type: none"><li>Inappropriate container or specimen type for the test requested.</li></ul>	<ul style="list-style-type: none"><li>Submitting agency will be notified and new specimens will be requested</li></ul>

### NOTE:

- All specimens referred to and received at CARPHA remain the property of CARPHA*



## CARPHA Laboratory Procedure Manual

Section: QSE 05 – Process Control

Title: Laboratory User Manual

Doc. No: GUL-Q05-001

Page 10 of 58

Effective date: 01.07.2013

Review date: 01.07.2014

Edition: 1

### Laboratory Testing Services

This section outlines investigations offered by all the departments of the laboratory. These guidelines are applicable for routine specimen referrals.

Please note - Potential outbreaks are managed on a case by case basis following contact with the Laboratory and Epidemiology divisions for further guidance.

Note:

#### **All specimens referred for serological testing assays should:**

- Have a minimum volume of 1.0 ml.
- Be maintained at temperatures within the range of 4<sup>0</sup>C to -20<sup>0</sup>C.
- Be contained in appropriate vials that do not exceed the dimensions of 1.5 cm diameter and 4.7 cm in height e.g. Nunc vial. Only vials with external threads should be used.

#### **SPECIMENS SUBMITTED UNDER THE EXPANDED PROGRAMME ON IMMUNIZATION (EPI)**

Please check the EPI field guide or the EPI manager in-country for further information for the following vaccine preventable diseases covered under the EPI elimination or eradication programme

- Congenital rubella syndrome
- Measles
- Poliomyelitis
- Rubella (German measles)

**CARPHA Laboratory Procedure Manual**

Section: QSE 05 – Process Control

Title: Laboratory User Manual

Doc. No: GUL-Q05-001

Page 11 of 58

Effective date: 01.07.2013

Review date: 01.07.2014

Edition: 1

**Laboratory Testing Services**

Matrix of Disease/Etiology Specimen Type/s Diagnostic Method and Turnaround Times

Disease/Aetiologic Agent	Comment	Specimen	Method	Turnaround Time (Days)
<i>Campylobacter</i>	Performed at CARPHA for countries without testing capability	- Isolate in Cary Blair media; - Stool	Culture and biochemical tests	7
Chlamydia infection	Please contact CARPHA before submission of specimens  (Sent to CARPHA's Reference Laboratory)	Vaginal discharge in transport media	PCR	14 – 21
Chicken pox (varicella)	Please contact CARPHA submission of specimens  (Sent to CARPHA's Reference Laboratory)	- Vesicle swab - Serum	- PCR - IgG ELISA	14 – 21
Chikungunya	Performed at CARPHA for outbreaks	- Acute serum (collected 1-4 days from onset);	PCR	7
Cholera	- Initial laboratory testing in country, - CARPHA: referral for further testing	- Isolate in maintenance media - Stool in Cary Blair media	- Serotyping - Confirmation	7
Ciguatera poisoning	Please contact CARPHA for discussion and decision making	–	–	–
Diphtheria	Performed at CARPHA for countries without testing capability	Throat swab in transport media	- Culture - Biochemical tests and gram staining	14
Dengue Fever; Dengue haemorrhagic fever	Performed at CARPHA for countries without testing capability	- Acute serum (collected 1-4 days from onset);	- PCR	7
Dengue shock syndrome		- Convalescent serum (collected 7-15 days from onset)	- IgM ELISA	7



**CARPHA Laboratory Procedure Manual**

**Section: QSE 05 – Process Control**

**Title: Laboratory User Manual**

**Doc. No: GUL-Q05-001**

**Page 12 of 58**

**Effective date: 01.07.2013**

**Review date: 01.07.2014**

**Edition: 1**

<b>Disease/Aetiologic Agent</b>	<b>Comment</b>	<b>Specimen</b>	<b>Method</b>	<b>Turnaround Time (Days)</b>
<i>E. coli</i> (pathogenic)	Performed at CARPHA for countries without testing capability	- Isolate in maintenance media; - Stool in Cary Blair media	- EIA assay; - Serotyping; - Confirmation	7
EBV	- Not routinely tested - CARPHA to be contacted for discussion and assistance prior to submission of specimens	Serum	- IgM ELISA	7
NeisseriaGonococcal infection	Performed at CARPHA for countries without testing capability	- Isolate in BHI with glycerol or on chocolate agar	- Culture; - Antimicrobial Resistance (AMR) testing	7-14
Influenza and other Respiratory syncytial, Parainfluenza 1 - 4, Metapneumovirus, Adenovirus, Rhinovirus	Performed at CARPHA for countries without testing capability	- Nasopharyngeal or oropharyngeal swabs, aspirate or washes; - Broncheoalveolar lavage, tracheal aspirates (collected within 1 -7 days of onset)	- PCR - Virus isolation	7 28
Leptospirosis	Performed at CARPHA for countries without testing capability	Serum (collected > 5 days after onset)	IgM ELISA	7
Malaria (indigenous and imported)	- Laboratory testing: in-country - CARPHA: to be contacted for discussion if necessary	Thick and thin slides	Microscopy	2
Meningitis infection (due to <i>Neisseria meningitidis</i> )	- Performed at CARPHA for countries without testing capability	Isolate in BHI with glycerol or on chocolate agar	- Culture; - Antimicrobial Resistance (AMR) testing;	7-14
Meningitis/Pneumonia (due to <i>Streptococcus pneumoniae</i> )	- Isolates to be submitted to CARPHA for further characterization.		- Serotyping	
Meningitis/Pneumonia (due to <i>Haemophilus influenzae</i> )				



**CARPHA Laboratory Procedure Manual**

**Section: QSE 05 – Process Control**

**Title: Laboratory User Manual**

**Doc. No: GUL-Q05-001**

**Page 13 of 58**

**Effective date: 01.07.2013**

**Review date: 01.07.2014**

**Edition: 1**

<b>Disease/Aetiologic Agent</b>	<b>Comment</b>	<b>Specimen</b>	<b>Method</b>	<b>Turnaround Time (Days)</b>
Norovirus	Performed at CARPHA for countries without testing capability	Stool	- PCR; - IgM ELISA	7
Opportunistic infections (e.g. <i>cryptosporidium</i> , <i>CMV</i> , <i>toxoplasma</i> , <i>pneumocystis</i> )*	Performed at CARPHA for countries without testing capability	Toxoplasma: Serum	IgM ELISA	7
		CMV:serum	IgM ELISA	7
		Cryptosporidium: Stool	Microscopy: Stool staining	7
		Cryptococcus neoformans: CSF	Microscopy: India ink staining	7
Pertussis	Performed at CARPHA for countries without testing capability	Nasopharyngeal or throat swab	- Culture; Referred for PCR testing	7
Plague	Sent to CARPHA's Reference Laboratory	- Blood; - Biopsy material from bubo	- Blood culture; - Microscopy; - Culture; - Antimicrobial Resistance (AMR) testing	14
Rabies (in humans)	CARPHA: to be contacted for discussion if necessary (Sent to CARPHA's Reference Laboratory)	-	-	-
Rotavirus	- Performed for countries without testing capability in outbreak situations. - Please contact CARPHA for discussion	- Stool	- Antigen ELISA  - PCR	7
Salmonellosis	- Performed at CARPHA for countries without testing capability	Isolate in maintenance media	- Serotyping; - Phage Typing of <i>S. enteritidis</i>	7 - 14
Shigellosis	- Isolates to be submitted for further characterization	Serotyping	Serotyping	7
Syphilis	Contact CARPHA - Testing to be decided based on the elimination algorithm	Serum	Latex agglutination	-



**CARPHA Laboratory Procedure Manual**

**Section: QSE 05 – Process Control**

**Title: Laboratory User Manual**

**Doc. No: GUL-Q05-001**

**Page 14 of 58**

**Effective date: 01.07.2013**

**Review date: 01.07.2014**

**Edition: 1**

<b>Disease/Aetiologic Agent</b>	<b>Comment</b>	<b>Specimen</b>	<b>Method</b>	<b>Turnaround Time (Days)</b>
Congenital syphilis	Contact CARPHA - Testing to be decided based on the elimination algorithm	Serum	Latex agglutination	–
*Tuberculosis (Pulmonary)	- Performed at CARPHA for countries without testing capability - Selected specimens sent to CARPHA's Reference Laboratory	Sputum	- Identification (PCR) - Drug Sensitivity Testing (PCR) -	4
Tuberculosis (Extra-pulmonary)	Please contact CARPHA submission of specimens	–	–	–
Typhoid and paratyphoid fever	Performed at CARPHA for countries without testing capability	Stool, Isolate in maintenance media	- Identification - Serotyping	7
Viral Encephalitis/ Meningitis	Performed at CARPHA for countries without testing capability	1 -2 mL acute CSF; nasopharyngeal swab in viral transport media, unpreserved stool	PCR (Enterovirus, HSV1 and HSV 2)	7
Viral Hepatitis A, E	Performed at CARPHA for outbreak investigation	Single serum	IgM ELISA	7
Viral Hepatitis B	Performed at CARPHA for countries without testing capability	Single serum	ELISA (surface antigen HBsAg)	7
Yellow fever	CARPHA for testing: (Sent to CARPHA's Reference Laboratory)	Single serum Viral Isolation (when BSL3 facility is available)	ELISA; PCR	21



# CARPHA Laboratory Procedure Manual

Section: QSE 05 – Process Control

Title: Laboratory User Manual

Doc. No: GUL-Q05-001

Page 15 of 58

Effective date: 01.07.2013

Review date: 01.07.2014

Edition: 1

## Entomology Specimen Referrals

The following table lists information relevant to the collection and testing of specimens for Entomology investigations.

**Note: All specimens sent to the Entomological unit must be accompanied by the following information:**

- Method of specimen collection
- Date and time of specimen collection
- Name of specimen collector
- Country and location
- Type of habitat (from which collection was made)

Test	Specimen recommended	Notes	Turnaround time (calendar days)
Insecticide resistance	<i>Aedes aegypti</i> mosquito eggs	On removal from ovitraps, the paper containing eggs should be placed in a container lined with damp paper towels. After 2-3 days, the paper should be removed from the container and left to air-dry for 1-2 days. Fold paper in two with the side containing the eggs on the inside.	42
Mosquito identification (larval specimen)	Specimen collected and killed in hot but NOT boiling water	Specimen should be sent in vials containing 70% ethanol.	7
Mosquito identification (adult specimen)	Specimen killed with chloroform, ether, carbon dioxide or rapidly frozen in a domestic refrigerator	The specimen should be packaged and sent in a small vial or cardboard box lined with grease-proof paper or paper towels.	7
Virus isolation: • Dengue fever	Live adult mosquitoes: <i>Aedes aegypti</i>	Individual vials should contain a pool of 20 adults. These vials should be lined with grease-proof paper and stored in a -70°C freezer until ready for shipment. <u>Overseas laboratories:</u> The vials must be transported to CARPHA in a container packed with dry ice. <u>Local Laboratories:</u> Live adult mosquitoes should be forwarded directly to CARPHA in ice coolers within 24 hours of collection.	28



**ANNEX 1  
Case Definition and Syndromic Diagnosis Flowcharts**

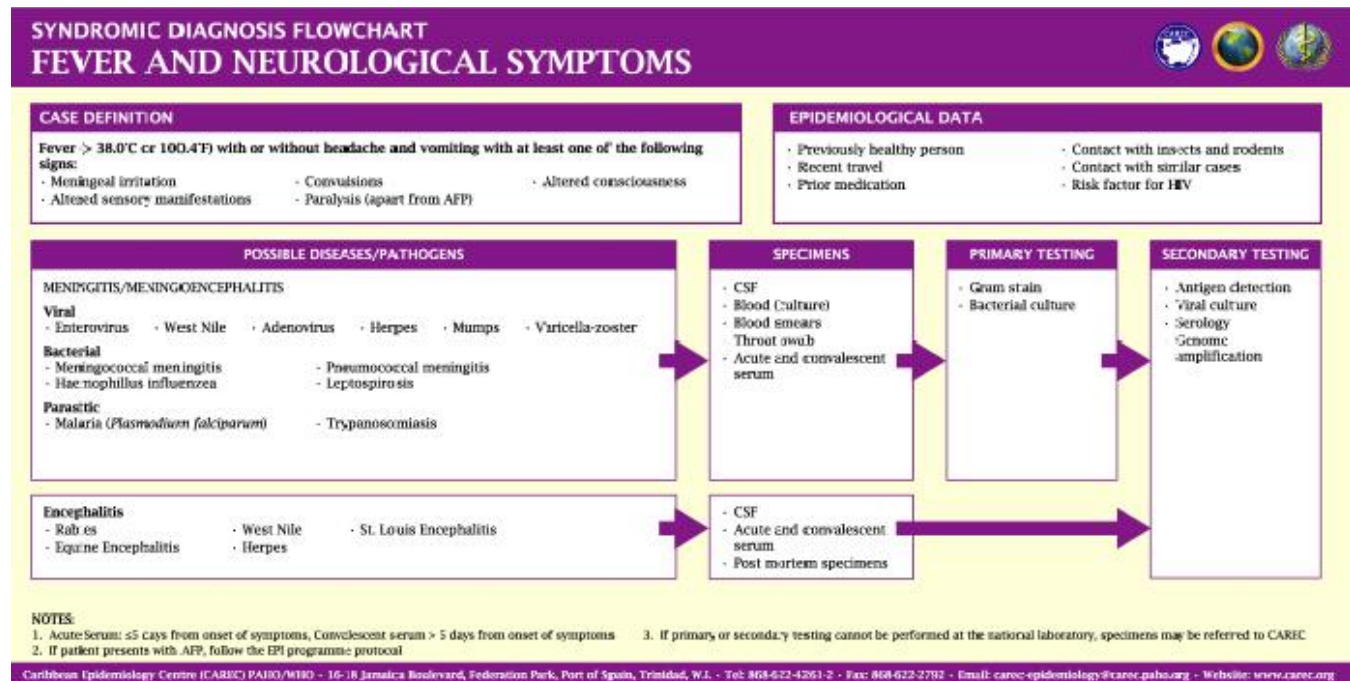
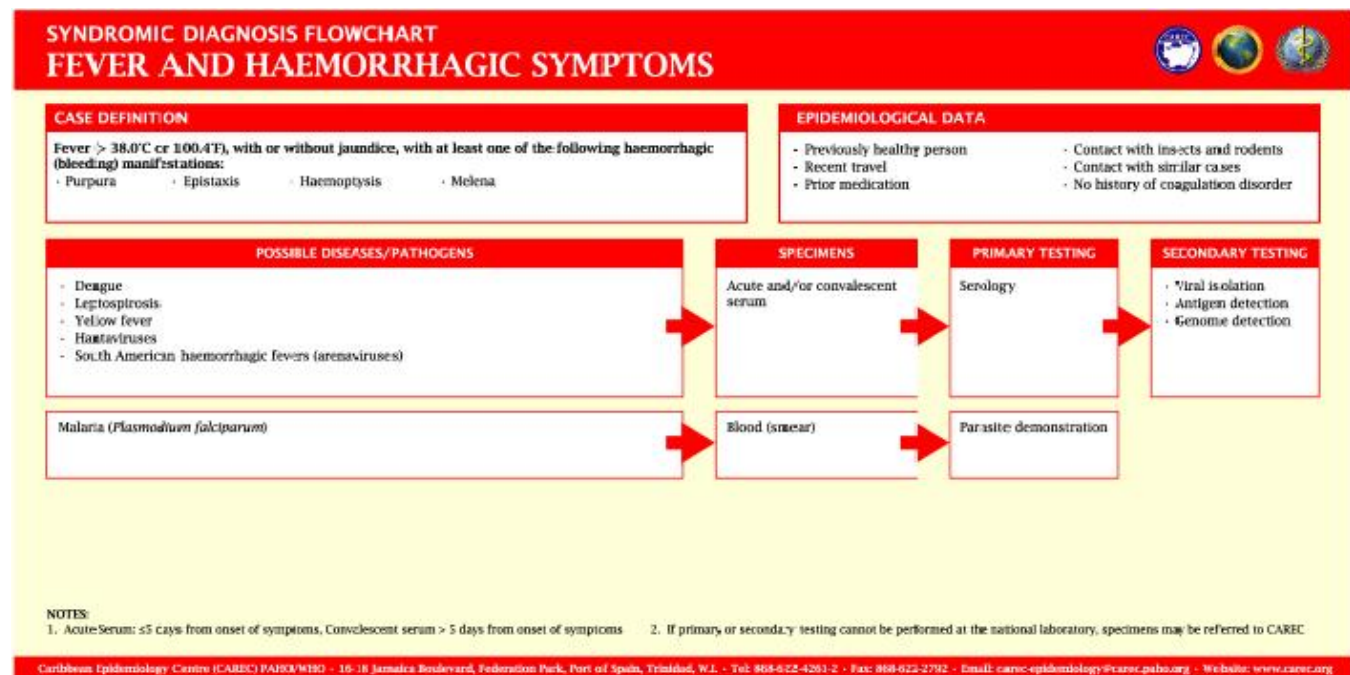



# CARPHA Laboratory Procedure Manual

Section: QSE 05 – Process Control

Title: Laboratory User Manual

Doc. No: GUL-Q05-001

Page 17 of 58

Effective date: 01.07.2013

Review date: 01.07.2014

Edition: 1

## SYNDROMIC DIAGNOSIS FLOWCHART FEVER AND RESPIRATORY SYMPTOMS



### CASE DEFINITION

Fever  $> 38.0^{\circ}\text{C}$  or  $100.4^{\circ}\text{F}$ , with one of the following symptoms, with or without respiratory distress

- Cough
- Sore Throat

### EPIDEMIOLOGICAL DATA

- Previously healthy person
- Risk factor for HIV
- Prior medication
- Recent travel
- Contact with animals
- Contact with similar cases

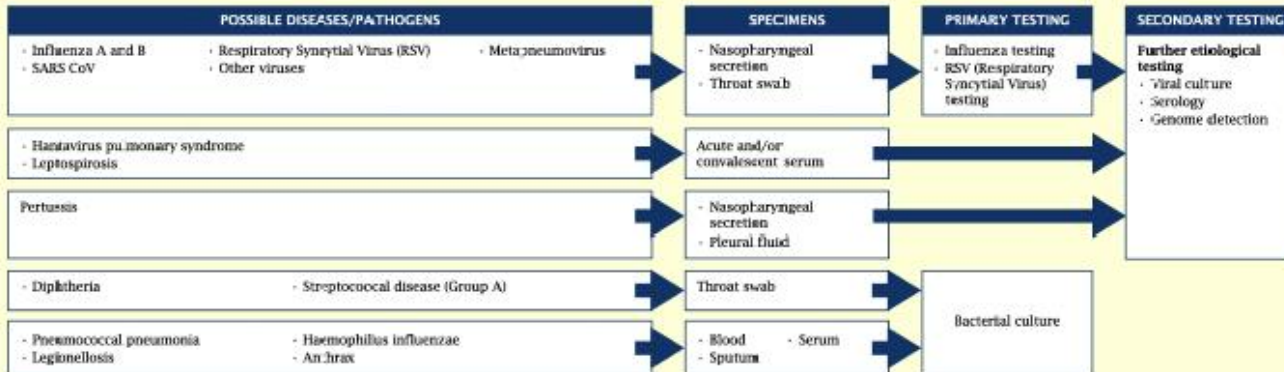

### NOTES:

1. Acute Serum:  $\leq 5$  days from onset of symptoms, Convalescent serum  $> 5$  days from onset of symptoms
2. If primary or secondary testing cannot be performed at the national laboratory, specimens may be referred to CAREC

Caribbean Epidemiology Centre (CAREC PAHO/WHO) - 16-18 Jamaica Boulevard, Federation Park, Port of Spain, Trinidad, W.I. - Tel: 868-622-4261-2 - Fax: 868-622-2792 - Email: carec-epidemiology@carec.paho.org - Website: www.carec.org

## SYNDROMIC DIAGNOSIS FLOWCHART GASTROENTERITIS/ACUTE DIARRHOEA SYNDROME



### CASE DEFINITION

Acute onset of diarrhoea, with or without fever, and presenting with 3 or more loose stools or watery stools in the past 24 hours, with or without dehydration, vomiting and/or visible blood

### EPIDEMIOLOGICAL DATA

- Previously healthy person
- Risk factor for HIV
- Recent Travel
- Food and water history
- Contact with similar cases

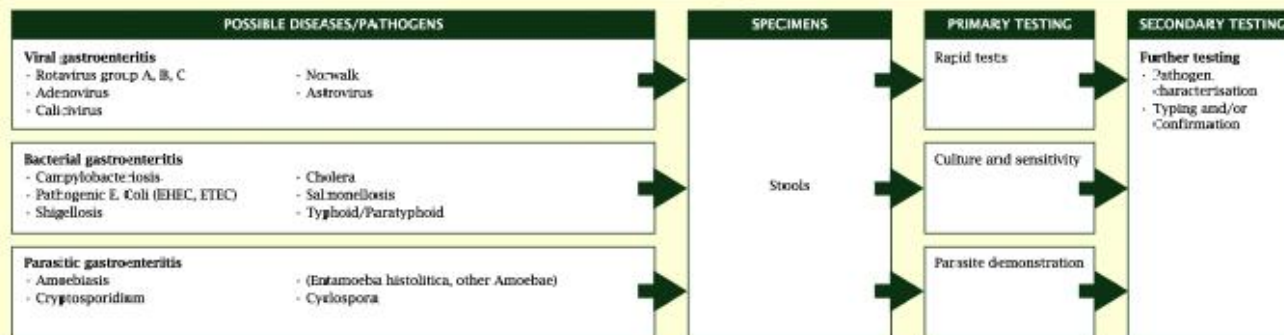

### NOTES:

1. Acute Serum:  $\leq 5$  days from onset of symptoms, Convalescent serum  $> 5$  days from onset of symptoms
2. If primary or secondary testing cannot be performed at the national laboratory, specimens may be referred to CAREC

Caribbean Epidemiology Centre (CAREC PAHO/WHO) - 16-18 Jamaica Boulevard, Federation Park, Port of Spain, Trinidad, W.I. - Tel: 868-622-4261-2 - Fax: 868-622-2792 - Email: carec-epidemiology@carec.paho.org - Website: www.carec.org



# CARPHA Laboratory Procedure Manual

Section: QSE 05 – Process Control

Title: Laboratory User Manual

Doc. No: GUL-Q05-001

Page 18 of 58

Effective date: 01.07.2013

Review date: 01.07.2014

Edition: 1

## SYNDROMIC DIAGNOSIS FLOWCHART UNDIFFERENTIATED FEVER



### CASE DEFINITION

Fever > 38.0°C or 100.4°F, with two or more of the following symptoms:

- Headache
- Nausea
- Retro-orbital pain
- Vomiting
- Arthralgia
- Jaundice
- Myalgia

### EPIDEMIOLOGICAL DATA

- Previously healthy person
- Recent travel
- Prior medication
- Contact with insects and rodents
- Contact with similar cases

### POSSIBLE DISEASES/PATHOGENS

- Dengue
- Leptospirosis
- Viral Hepatitis
- Other arboviral fevers
- Hantavirus

### SPECIMENS

Acute and/or convalescent serum

### PRIMARY TESTING

Serology

### SECONDARY TESTING

- Viral isolation
- Antigen detection
- Genome detection

- Brucellosis
- Typhoid/Paratyphoid
- Meningococcal infection

- Blood
- Serum

- Blood (culture)
- Serology

- Malaria (*Plasmodium vivax*)
- Borreliosis

- Blood (smear)
- Serum

- Parasite demonstration
- Serology

### NOTES:

1. Acute Serum: ≤5 days from onset of symptoms, Convalescent serum > 5 days from onset of symptoms
2. Measles and Rubella must be tested for if rash is present in children, as per the EPH Programme protocol
3. If primary or secondary testing cannot be performed at the national laboratory, specimens may be referred to CAREC



## CARPHA Laboratory Procedure Manual

Section: QSE 05 – Process Control

Title: Laboratory User Manual

Doc. No: GUL-Q05-001

Page 19 of 58

Effective date: 01.07.2013

Review date: 01.07.2014

Edition: 1

### ANNEX 2: SPECIMEN COLLECTION GUIDELINES

#### PURPOSE

To describe methods for the collection and transport of the following specimens (most commonly submitted specimens are italicised):

- A. Blood
  - Venous Blood Samples
  - *Serum from Blood*
  - Capillary Blood Samples
  
- B. Respiratory Tract Samples
  - Upper Respiratory Tract Specimens
    - *Throat Swab*
    - *Pre-Nasal and Post Nasal Swab*
    - Aspirates
  
  - Lower Respiratory Tract Specimens
  
- C. Cerebrospinal Fluid
  
- D. Faecal Specimens
  - *Stool Specimen*
  - Rectal Swab from Infants
  
- E. Eye Specimen
  
- F. Samples From For Skin Lesions
  - Vesicular or Vesiculo-Pustular Rash
  - Crusting Stage
  - Aspiration of Abscesses
  
- G. Urine Specimens
  
- H. Post- Mortem Specimens
  - Collection of Tissue Specimens
  
- H. Sputum Specimens for TB Testing



## CARPHA Laboratory Procedure Manual

Section: QSE 05 – Process Control

Title: Laboratory User Manual

Doc. No: GUL-Q05-001

Page 20 of 58

Effective date: 01.07.2013

Review date: 01.07.2014

Edition: 1

### A. COLLECTION OF BLOOD SPECIMENS

Blood and separated serum are the most common specimens taken to investigate the etiology of communicable diseases. Venous blood can be used for isolation and identification of pathogens using sub-culture and inoculation techniques. Blood is also separated into serum for the detection of genetic material (e.g. using the polymerase chain reaction), specific antibodies, antigens, or toxins (e.g. by ELISA). For the processing of most specimens for diagnosis of viral pathogens, serum is preferable to un-separated blood except where otherwise directed. When specific antibodies are being assayed, it is often useful to collect paired sera, i.e. an acute sample taken at the onset of illness and a convalescent sample collected one to four weeks later. Blood can also be collected by finger prick for the preparation of slides for microscopy or for absorption onto special filter paper discs for analysis. Whenever possible, blood specimens for culture should be taken before antibiotics are administered to the patient.

**NOTE: Collect acute and convalescent blood for serology with at least 2 weeks between acute and convalescent specimens**

#### A.1.0 VENOUS BLOOD SAMPLES

##### MATERIALS

SUPPLIES	REAGENTS
<ul style="list-style-type: none"><li>• Disposable latex or vinyl gloves</li><li>• Tourniquet, Vacutainer, Monovette, or similar vacuum blood collection devices, or disposable syringes and needles</li><li>• Vacutainer, blood culture bottles (50ml for adults, 25ml for children) with appropriate media</li><li>• Swabs, gauze pads, band-aid</li><li>• Labels and indelible marker pen.</li></ul>	<ul style="list-style-type: none"><li>• Skin disinfection: 70% alcohol (isopropyl alcohol, ethanol) or 10% povidone, iodine,</li></ul>



# CARPHA Laboratory Procedure Manual

Section: QSE 05 – Process Control

Title: Laboratory User Manual

Doc. No: GUL-Q05-001

Page 21 of 58

Effective date: 01.07.2013

Review date: 01.07.2014

Edition: 1

## PROCEDURE

STEP	ACTION
1	<ul style="list-style-type: none"><li>Place a tourniquet above the venepuncture site.</li></ul>
2	<ul style="list-style-type: none"><li>Palpate and locate the vein. It is critical to disinfect the venepuncture site meticulously with 10% povidone iodine or 70% isopropyl alcohol by swabbing the skin concentrically from the centre of the venepuncture site outwards.</li><li>Let the disinfectant evaporate. Do not revalidate the vein again.</li><li>Perform venepuncture.</li></ul> <p><b><i>If withdrawing with conventional disposable syringes withdraw the following volumes</i></b></p> <p>ADULTS: 5-10ml CHILDREN: 2-5ml INFANTS: 0.5-2ml</p> <p><b><i>If withdrawing using vacuum systems, withdraw the desired amount of blood directly into each transport tube and culture bottle.</i></b></p>
4	<ul style="list-style-type: none"><li>Remove the tourniquet.</li><li>Apply pressure to site until bleeding stops, and apply sticking plaster (if desired).</li></ul>
5	<ul style="list-style-type: none"><li>Using aseptic technique, transfer the specimen to the relevant cap transport tubes and culture bottles.</li><li>Secure caps tightly.</li></ul> <p><b><i>Be sure to follow manufacturer's instructions on the correct amount and method for inoculation of blood culture bottles.</i></b></p>
6	<ul style="list-style-type: none"><li>Label the tube, including the unique patient identification number using indelible marker pen.</li></ul>
7	<ul style="list-style-type: none"><li>Do not recap used sharps.</li><li>Discard directly into the sharps disposal container</li></ul>
8	<ul style="list-style-type: none"><li>Complete the case investigation and the laboratory request forms using the same identification number</li></ul>



# CARPHA Laboratory Procedure Manual

Section: QSE 05 – Process Control

Title: Laboratory User Manual

Doc. No: GUL-Q05-001

Page 22 of 58

Effective date: 01.07.2013

Review date: 01.07.2014

Edition: 1

## HANDLING AND TRANSPORT

- Blood culture bottles and blood sample tubes should be transported upright and secured in a screw cap container or in a rack in a transport box.
- Cushion or suspend bottles during transport over rough terrain to prevent lysis of red cells. There should be sufficient absorbent paper around blood containers to soak up all liquid in case of a spill.
- If the specimen reaches the laboratory within 24 hours, most bacterial pathogens can be recovered from blood cultures transported at ambient temperature.

**NOTE: Collect acute and convalescent blood for serology with at least 2 weeks between acute and convalescent specimens**

## A.2.0 COLLECTION AND SEPARATION OF SERUM FROM BLOOD

### MATERIALS

EQUIPMENT	SUPPLIES	REAGENTS
<ul style="list-style-type: none"> <li>• Centrifuge</li> </ul>	<ul style="list-style-type: none"> <li>• Disposable latex or vinyl gloves</li> <li>• Tourniquet, Vacutainer, Monovette, or similar vacuum blood collection devices, or disposable syringes and needles</li> <li>• Vacutainer, blood culture bottles (50ml for adults, 25ml for children) with appropriate media</li> <li>• Swabs, gauze pads, band-aid</li> <li>• Labels and indelible marker pen.</li> <li>• Sterile Pasteur pipettes and bulb, or soft, disposable transfer pipettes (pastettes). The latter are easy to handle and dispose of in the field laboratory,</li> <li>• Sterile screw-cap vials</li> </ul>	<ul style="list-style-type: none"> <li>• Skin disinfection: 70% alcohol (isopropyl alcohol, ethanol) or 10% povidone, iodine,</li> </ul>

**CARPHA Laboratory Procedure Manual**

Section: QSE 05 – Process Control

Title: Laboratory User Manual

Doc. No: GUL-Q05-001

Page 23 of 58

Effective date: 01.07.2013

Review date: 01.07.2014

Edition: 1

**PROCEDURE**

STEP	ACTION
	<ul style="list-style-type: none"><li>•</li></ul>
2	<ul style="list-style-type: none"><li>• Allow the blood specimen to clot for 30 minutes at ambient temperature</li><li>• The specimen should be centrifuged at the laboratory at low speed (1000g for 10 minutes) to remove residual blood cells.</li><li>• When serum separation is performed in a field laboratory, proper safety precautions should be taken.</li><li>• Ensure that the centrifuge is in good condition and that the tubes are properly closed and balanced to avoid breakage and spilling.</li><li>• If viral haemorrhagic fever is strongly suspected, samples should only be processed in properly equipped, specialized laboratories.</li><li>• Discuss with the laboratory personnel whether a separation gel blood tube (see Note) would be acceptable in this case.</li></ul>
3.	<ul style="list-style-type: none"><li>• Separate the serum aseptically from the clot using a sterile Pasteur pipette and bulb or soft, disposable transfer pipette.</li><li>• Transfer to a screw cap vial. Secure the cap tightly.</li></ul>
4.	<ul style="list-style-type: none"><li>• If a centrifuge is not available and there will be a delay before samples can be transported to a laboratory, serum may still be separated carefully from the retracted clot using a disposable transfer pipette.</li><li>• Allow 4-6 hours to elapse after taking the blood sample to ensure adequate clot retraction.</li><li>• Using the transfer pipette, remove the clear yellow serum whilst taking care to keep the tip as far as possible from the clot, and avoid agitating the blood tube during the removal process. (This may be easier if a separation gel collection tube has been used).</li><li>• Transfer to plastic screw-cap vial and secure cap tightly.</li></ul>
5.	<ul style="list-style-type: none"><li>• Label the vial with the same patient details that appear on the blood sample tube.</li></ul>

NOTE: *In some instances it may be acceptable to use a special blood tube containing a separation gel, which encourages separation of serum from clot. In this case, the centrifugation step is eliminated. This has the advantage of ease and safety of specimen processing under field conditions. However it is important to check with the laboratory in advance to ensure that these devices are appropriate for your particular investigation.*



**CARPHA Laboratory Procedure Manual**

Section: QSE 05 – Process Control

Title: Laboratory User Manual

Doc. No: GUL-Q05-001

Page 24 of 58

Effective date: 01.07.2013

Review date: 01.07.2014

Edition: 1

**HANDLING AND TRANSPORT**

- If serum will be required for testing, separation from blood should take place as soon as possible, preferably within 24 hours at ambient temperature.
- If the specimen will not reach a laboratory for processing within 24 hours, serum should, if at all possible, be separated from blood prior to transportation.
- Sera may be stored at 4-8° for up to 10 days. If serological testing is to be delayed for a longer period, serum samples may be frozen.
- If separation on site is not possible, or is inadvisable for safety reasons, the blood sample should be stored at 4-8°C.
- Protect such un-separated samples from excessive vibrations while transporting.
- Un-separated blood samples should not be frozen.

**A.3.0 CAPILLARY BLOOD SAMPLES****MATERIALS**

EQUIPMENT	SUPPLIES	REAGENTS
	<ul style="list-style-type: none"> <li>• Disposable sterile lancets</li> <li>• Glass slides, cover slips, slide box</li> <li>• Filter paper</li> </ul>	<ul style="list-style-type: none"> <li>• Fixatives such as methanol</li> </ul>

**PROCEDURE**

STEP	ACTION
1	<ul style="list-style-type: none"> <li>• Disinfect finger or thumb for adults, thumbs for children or side of heel for infants, by swabbing with 70% isopropyl alcohol, and prick with a sterile lancet.</li> <li>• Wipe away the first drop of blood.</li> </ul>
2	<ul style="list-style-type: none"> <li>• Discard used lancets directly into the sharps disposal container</li> </ul>
3	<ul style="list-style-type: none"> <li>• Collect blood directly onto labelled glass microscope slides and/or filter paper.</li> </ul>



## CARPHA Laboratory Procedure Manual

Section: QSE 05 – Process Control

Title: Laboratory User Manual

Doc. No: GUL-Q05-001

Page 25 of 58

Effective date: 01.07.2013

Review date: 01.07.2014

Edition: 1

### METHOD OF PREPARATION OF BLOOD FILMS

Blood films should be made by trained personnel.

#### Thick films for microscopy

STEP	ACTION
1	<ul style="list-style-type: none"><li>Label the slide with patient identification number and name</li></ul>
2	<ul style="list-style-type: none"><li>Disinfect and prick the site with a lancet as described above</li></ul>
3	<ul style="list-style-type: none"><li>Touch one or more large drops of blood onto the centre of the slide making sure that the slide does not touch the skin.</li></ul>
4	<ul style="list-style-type: none"><li>Spread the blood in a circle about 1cm in diameter using the corner of another glass slide</li></ul>
5	<ul style="list-style-type: none"><li>Air-dry the film in a horizontal position.</li><li>Do not dry the film by heating over a flame or other heat source.</li></ul>

#### Thin films for microscopy

STEP	ACTION
1	<ul style="list-style-type: none"><li>Label the slide with patient identification number and name</li></ul>
2	<ul style="list-style-type: none"><li>Touch another drop of blood to the glass slide about 2 cm from one end making sure that the slide does not touch the skin.</li></ul>
3	<ul style="list-style-type: none"><li>Place the slide horizontally on a flat surface</li></ul>
4	<ul style="list-style-type: none"><li>Hold the slide of a second clean glass slide (the spreader) on to the center of the specimen slide and move it back until it touches the drop and the blood spreads along its base</li></ul>
5	<ul style="list-style-type: none"><li>At an angle of about 45°, move the spreader firmly and steadily across the specimen slide and air dry the film quickly.</li><li>DO NOT dry over a flame or other heat source</li></ul>
6	<ul style="list-style-type: none"><li>Fix the dried film by dipping the glass slide in methanol or other fixative for a few seconds and air dry.</li></ul>



**CARPHA Laboratory Procedure Manual**

**Section: QSE 05 – Process Control**

**Title: Laboratory User Manual**

**Doc. No: GUL-Q05-001**

**Page 26 of 58**

**Effective date: 01.07.2013**

**Review date: 01.07.2014**

**Edition: 1**

**6.0 HANDLING AND TRANSPORT**

Air dried and /or fixed films are transported at ambient temperature preferably within 24 hours of specimen collection. They must not be refrigerated. Thick and thin films are usually kept in separate slide boxes



## CARPHA Laboratory Procedure Manual

Section: QSE 05 – Process Control

Title: Laboratory User Manual

Doc. No: GUL-Q05-001

Page 27 of 58

Effective date: 01.07.2013

Review date: 01.07.2014

Edition: 1

### B. COLLECTION OF RESPIRATORY TRACT SAMPLES

**Preferably specimens should be taken within the first 3 days after onset of symptoms for most respiratory infections**

Specimens are collected from the upper or lower respiratory tract, depending on the site of infection. Upper respiratory tract pathogens (viral and bacterial) are found in throat nasopharyngeal specimens. Lower respiratory tract pathogens are found in sputum specimens. For organisms such as *Legionella*, culture is difficult, and diagnosis is best based on the detection of antigen excreted in the urine.

When acute epiglottitis is suspected, no attempt should be made to take throat or pharyngeal specimens since these procedures may precipitate respiratory obstruction. Epiglottitis is generally confirmed by lateral neck x-ray, but the etiological agent may be isolated on blood culture.

#### MATERIALS

SUPPLIES	REAGENTS
<ul style="list-style-type: none"><li>• Dacron and cotton swabs</li><li>• Tongue depressor</li><li>• Flexible wire calcium alginate tipped swab (for suspected pertussis)</li><li>• Nasal speculum (for suspected pertussis) – not essential</li><li>• Suction apparatus or 20-50ml syringe</li><li>• Sterile screw-cap tubes, and wide mouthed clean sterile jars (minimum volume 25 ml)</li></ul>	<ul style="list-style-type: none"><li>• Transport media – bacterial and viral</li></ul>



# CARPHA Laboratory Procedure Manual

Section: QSE 05 – Process Control

Title: Laboratory User Manual

Doc. No: GUL-Q05-001

Page 28 of 58

Effective date: 01.07.2013

Review date: 01.07.2014

Edition: 1

## B.1.0 UPPER RESPIRATORY TRACT SPECIMENS

### B.1.1 THROAT SWAB

#### PROCEDURE

STEP	ACTION
1	<ul style="list-style-type: none"><li>• Hold the tongue down with the depressor.</li><li>• Use a strong light source to locate areas of inflammation and exudate in the posterior pharynx and the tonsillar region of the throat behind the uvula</li></ul>
2	<ul style="list-style-type: none"><li>• Rub the area back and forth with a Dacron or calcium alginate swab.</li><li>• Withdraw the swab without touching cheeks, teeth or gums and insert into a screw-cap vial containing viral or bacterial transport medium.</li></ul>
3	<ul style="list-style-type: none"><li>• Break off the top part of the stick without touching the tube and tighten the screw cap firmly</li></ul>
4	<ul style="list-style-type: none"><li>• Label the specimen containers</li></ul>
5	<ul style="list-style-type: none"><li>• Complete the laboratory request form.</li></ul>

### B.1.2 PRE-NASAL AND POST NASAL SWAB

#### PROCEDURE

STEP	ACTION
1	Seat the patient comfortably, tilt the head back and insert the nasal speculum
2	Insert a flexible swab beneath the inferior turbinate of either nostril or leave in place for a few seconds and move the swab upwards into the nasopharyngeal space.
3	Rotate the swab on the nasopharyngeal membrane a few times; slowly withdraw with a rotating motion against the mucosal surface of the nostril.
4	Remove the swab carefully and insert it into a screw-cap tube containing transport medium.
5	Repeat the procedure in the other nostril using a new sterile swab
6	Label the vial with patient's name type of specimen and date of collection



## CARPHA Laboratory Procedure Manual

Section: QSE 05 – Process Control

Title: Laboratory User Manual

Doc. No: GUL-Q05-001

Page 29 of 58

Effective date: 01.07.2013

Review date: 01.07.2014

Edition: 1

### B.1.3 ASPIRATES

#### PROCEDURE

STEP	ACTION
1	<ul style="list-style-type: none"><li>Nasopharyngeal secretions are aspirated through a catheter connected to a mucus trap and fitted to a vacuum source.</li></ul>
2	<ul style="list-style-type: none"><li>The nasal aspirates are collected by introducing a few ml of saline into the nose with a syringe fitted with a fine tubing or catheter.</li></ul>
3	<ul style="list-style-type: none"><li>The catheter is inserted into a nostril parallel to the palate.</li><li>The vacuum is then applied and the catheter is slowly withdrawn with a rotation motion.</li></ul>
4	<ul style="list-style-type: none"><li>Mucus from the other nostril is collected with the same catheter in a similar manner.</li></ul>
5	<ul style="list-style-type: none"><li>After mucus has been collected from both nostrils, the catheter is flushed into a screw cap vial with 3 ml viral transport media</li></ul>
6	<ul style="list-style-type: none"><li>Label the vial with patient's name type of specimen and date of collection</li></ul>

### B.2.0 LOWER RESPIRATORY TRACT SPECIMENS

#### B.2.1 SPUTUM

#### PROCEDURE

STEP	ACTION
1	<ul style="list-style-type: none"><li>Instruct patient to take a deep breath and cough up sputum directly into a wide mouth sterile container.</li><li>Avoid saliva or postnasal discharge.</li><li>Minimum volume should be about 1 ml</li></ul>
2	<ul style="list-style-type: none"><li>Label the specimen containers</li></ul>
3	<ul style="list-style-type: none"><li>Complete the laboratory request forms</li></ul>



**CARPHA Laboratory Procedure Manual**

**Section: QSE 05 – Process Control**

**Title: Laboratory User Manual**

**Doc. No: GUL-Q05-001**

**Page 30 of 58**

**Effective date: 01.07.2013**

**Review date: 01.07.2014**

**Edition: 1**

**HANDLING AND TRANSPORT**

- All respiratory specimens except sputum are transported in appropriate bacterial/viral media
- Transport as quickly as possible to the laboratory to reduce overgrowth by commensal oral flora.
- For transit periods up to 24 hours, transport bacterial specimens at ambient temperature and viruses at 4-8°C in appropriate media.



## CARPHA Laboratory Procedure Manual

Section: QSE 05 – Process Control

Title: Laboratory User Manual

Doc. No: GUL-Q05-001

Page 31 of 58

Effective date: 01.07.2013

Review date: 01.07.2014

Edition: 1

### C. COLLECTION OF CEREBROSPINAL FLUID

CSF is used in the diagnosis of viral, bacterial, parasitic and fungal meningitis  
The specimen must be taken by a physician or a person experienced in the procedure.

#### MATERIALS

EQUIPMENT	SUPPLIES	REAGENTS
<ul style="list-style-type: none"><li>Water manometer</li></ul>	<ul style="list-style-type: none"><li>Lumbar puncture tray which includes</li><li>Sterile materials: gloves, cotton wool, towels or drapes</li><li>Two lumbar puncture needles, small bore with stylet</li><li>Six small sterile screw-cap tubes and tube rack.</li><li>Microscope slides and slide boxes</li></ul>	<ul style="list-style-type: none"><li>Local anaesthetic, needle, syringe</li></ul>

#### PROCEDURE

- As only specially trained personnel should be involved in the collection of CSF samples, the method is not described in this document.
- CSF is collected directly into the separate screw-cap tubes.
- If the samples will not be promptly transported, separate tubes should be collected for bacterial and viral processing.

#### HANDLING AND TRANSPORT

- In general, specimens should be delivered to the laboratory and processed as soon as possible.
- CSF specimens for bacteriology are transported at ambient temperature, generally with transport media. They must **NEVER** be refrigerated as many of the relevant pathogens do not survive well at low temperatures
- CSF specimens for virology do not need transport medium. They may be transported at 4-8°C for up to 48 hours, or at -70°C for longer periods.



**CARPHA Laboratory Procedure Manual**

Section: QSE 05 – Process Control

Title: Laboratory User Manual

Doc. No: GUL-Q05-001

Page 32 of 58

Effective date: 01.07.2013

Review date: 01.07.2014

Edition: 1

**D. COLLECTION OF FAECAL SAMPLES**

Stool specimens are most useful for microbiological diagnosis if collected soon after onset of diarrhoea (for viruses < 48 hours for bacteria < 4 days), and preferably before the initiation of antibiotic therapy. If required, two or three specimens may be collected on separate days for bacterial diarrhoea. Stool is the preferred specimen for culture of bacterial, viral and parasitic diarrhoeal pathogens. Rectal swabs showing faeces may also be used from infants. In general, rectal swabs are not recommended for the diagnosis of viruses.

**MATERIALS**

SUPPLIES	REAGENTS
<ul style="list-style-type: none"> <li>Clean, dry, leak-proof screw cap container and tape.</li> </ul>	<ul style="list-style-type: none"> <li>Appropriate bacterial transport media for transport of rectal swabs from infants</li> <li>Parasitology transport pack: 10% formalin in water, polyvinyl isopropyl alcohol (PVA).</li> </ul>

**PROCEDURE****A. Method for collecting a stool specimen:**

STEP	ACTION
1	Collect freshly passed stool, 5ml liquid or 5g solid (pea-size), in a container.
2	Label the container

**B. Method of collecting a rectal swab from infants:**

STEP	ACTION
1	Moisten a swab in sterile saline
2	Insert that swab tip just past the anal sphincter and rotate gently
3	Withdraw the swab and examine to ensure that the cotton top is stained with faeces
4	Place the swab in sterile tube/container containing the appropriate bacterial or viral transport medium.
5	Break off the top part of the stick without touching the tube and tighten the screw cap firmly.
6	Label the vial with patient's name type of specimen and date of collection



## CARPHA Laboratory Procedure Manual

Section: QSE 05 – Process Control

Title: Laboratory User Manual

Doc. No: GUL-Q05-001

Page 33 of 58

Effective date: 01.07.2013

Review date: 01.07.2014

Edition: 1

### HANDLING AND TRANSPORT

- Stool specimens should be transported at 4-8°C. Bacterial yields may fall significantly if specimens are not processed within 1-2 days of collection. *Shigella* is particularly sensitive to elevated temperatures.
- Specimens to be examined for parasites should be mixed with 10% formalin or PVA (3 parts stool to 1 part preservative).
- Transport at ambient temperature in containers sealed in plastic bags.



# CARPHA Laboratory Procedure Manual

Section: QSE 05 – Process Control

Title: Laboratory User Manual

Doc. No: GUL-Q05-001

Page 34 of 58

Effective date: 01.07.2013

Review date: 01.07.2014

Edition: 1

## E. COLLECTION OF EYE SPECIMENS

Conjunctival and corneal swabs and smears are the usual specimens collected to diagnose acute bacterial or viral (kerato) conjunctivitis. Label all specimens as conjunctival or corneal and indicate whether the specimen was taken from the left or right eye. Strict aseptic technique is essential when collecting and processing these specimens. All medicines and droppers that come in contact with patients should be discarded.

While corneal scrapings may occasionally prove useful in improving the utility of corneal specimens for diagnosis of some infections, these are not generally infections which are epidemic-prone. Corneal scrapings must only be collected by an ophthalmologist or other trained persons. For these reasons, instructions for taking corneal scrapings will not be given here.

### MATERIALS

SUPPLIES	REAGENTS
<ul style="list-style-type: none"> <li>• Sterile gloves.</li> <li>• Glass slides, glass slide marker, slide holder box</li> </ul> <p>Glove and protective goggles should be worn if epidemic keratoconjunctivitis is suspected</p>	<ul style="list-style-type: none"> <li>• Sterile calcium alginate and/or cotton swabs. (Do not use calcium alginate swabs for virology specimens)</li> <li>• Vials containing sterile saline and viral transport media</li> </ul>

### PROCEDURE

#### Method of collection of conjunctival swabs

STEP	ACTION
1	Clean the skin around the eye with a mild antiseptic
2	Moisten a swab in sterile saline and roll over the conjunctiva in a circular manner
3	Insert the swab into a sterile screw-cap vial containing the appropriate transport media for bacteria.
4	Break off the top part of the stick without touching the tip of the tube and tighten the screw cap firmly
5	Repeat the procedure with a tube containing the appropriate viral transport medium
6	Label the vial with patient's name type of specimen and date of collection



## CARPHA Laboratory Procedure Manual

Section: QSE 05 – Process Control

Title: Laboratory User Manual

Doc. No: GUL-Q05-001

Page 35 of 58

Effective date: 01.07.2013

Review date: 01.07.2014

Edition: 1

### Method of preparation for microscopy smears

STEP	ACTION
1	<ul style="list-style-type: none"><li>• Prepare two smears onto clean glass slides with a fresh conjunctival swab.</li><li>• This should be done on-site if possible. Otherwise, specimens may be sent to the laboratory in appropriate transport media for the preparation of smears.</li><li>• Note that it is not possible to prepare smears from swabs transported in certain media, such as those containing charcoal.</li><li>• For detection of <i>Chlamydia</i>, it is <b>essential</b> that smears be prepared on-site prior to transport.</li></ul>
2	<ul style="list-style-type: none"><li>• Label the glass slides and put into a slide carrier or others appropriate box.</li><li>• <b>DO NOT</b> refrigerate or freeze the slides.</li></ul>

### HANDLING AND TRANSPORT

- Specimens for detection of bacterial pathogens are transported at ambient temperature in appropriate bacterial transport medium
- Specimens for viral detection are transported at 4-8°C in viral transport medium. Swabs in viral transport medium may also be frozen in liquid nitrogen.

Microscopic slides are air dried and transported at ambient temperature in a slide box.

**CARPHA Laboratory Procedure Manual**

Section: QSE 05 – Process Control

Title: Laboratory User Manual

Doc. No: GUL-Q05-001

Page 36 of 58

Effective date: 01.07.2013

Review date: 01.07.2014

Edition: 1

**F. COLLECTING OF SAMPLES FROM FOR SKIN LESIONS**

For most dermatological conditions, diagnosis may be established on the basis of physical examination and clinical history without the collection of diagnostic specimens. Important characteristics to be noted on physical examination include the nature of the skin lesions (erythematous, macular, papular, maculopapular, vesicular, bullous, petechial, purpuric, etc.) and the anatomic distribution of spread (central, peripheral, diffuse, etc.) In cases of indeterminate diagnoses, unusual presentations, and some rare conditions, collection of specimens from rashes and/or skin lesions may be necessary. In the case of vesicular rashes, specimens for microscopy and culture are taken directly from vesicles. In other exanthemata (macular and/or papular), the diagnosis may be more readily established from alternative specimens (e.g. blood cultures, serology). In suspected cutaneous anthrax or bubonic plague, specimens from the skin lesions (scars and buboes, respectively) and blood cultures may be taken.

**MATERIALS**

SUPPLIES	REAGENTS
<ul style="list-style-type: none"> <li>• Sterile swabs and appropriate transport media</li> <li>• Sterile screw cap vials</li> <li>• Sterile lancets or needles (for piercing of vesicles).</li> <li>• Syringe with wide-bore needle (for aspiration of abscesses/buboes)</li> <li>• Wide mouth screw-cap containers (for biopsy specimens)</li> <li>• Glass slides and slide boxes</li> </ul>	<ul style="list-style-type: none"> <li>• Sterile saline</li> </ul>

**PROCEDURE****I. Vesicular or vesiculo-pustular rash and Slide preparation (for diagnosis of viral infections).**

STEP	ACTION
1	HSV-infected cells are present in greatest numbers in the base of the vesicles or ulcers that are useful for direct HSV-1 and HSV-2 antigen detection.
2	Clean the fresh mature vesicle or ulcer with 70% ethanol.
3	Using a tuberculin syringe fitted with 26-27 gauge needle, insert the needle, bevel edge up, into the base of the vesicle.

**CARPHA Laboratory Procedure Manual**

Section: QSE 05 – Process Control

Title: Laboratory User Manual

Doc. No: GUL-Q05-001

Page 37 of 58

Effective date: 01.07.2013

Review date: 01.07.2014

Edition: 1

STEP	ACTION
4	Aspirate fluid and immediately, carefully inject the fluid into a vial containing 1- 2ml viral transport media; rinse once.
5	Lift the membrane of the vesicle and using a sterile Dacron swab, firmly rub at the base of the ulcer ( <i>Calcium alginate swabs cannot be used</i> ).
6	Immediately place the swab in the vial containing viral transport media.
7	Carefully scrape cells from base of the ulcer with scalpel or curette.
8	Rinse the lesion with two to three drops of viral transport media to make a cell suspension.
9	Aspirate the suspension and prepare three spots on a clean glass microscope slide
10	The slide should be left to dry in air.
11	Fix in cold acetone
12	Place in a slide box for transport to the laboratory

**II. Crusting stage**

STEP	ACTION
1	<ul style="list-style-type: none"><li>• Gently ease off crust with a lancet or scalpel and a pair of disposable forceps</li></ul>
2	<ul style="list-style-type: none"><li>• Take 5-10 crusts, place them in a plastic screw-cap vial. Make sure the lid is tightly closed.</li></ul>
3	<ul style="list-style-type: none"><li>• Label the specimen containers</li></ul>
4	<ul style="list-style-type: none"><li>• Discard forceps, lancets and scalpels into sharps disposal container.</li><li>• Do not re-use forceps on specimens from another patient.</li></ul>

**If cutaneous anthrax is suspected, the vesicular fluid under the scar is a better diagnostic specimen than a piece of the scar.**



## CARPHA Laboratory Procedure Manual

Section: QSE 05 – Process Control

Title: Laboratory User Manual

Doc. No: GUL-Q05-001

Page 38 of 58

Effective date: 01.07.2013

Review date: 01.07.2014

Edition: 1

### III. Aspiration of abscesses

**Aspiration of abscesses should only be performed by experienced personnel**

STEP	ACTION
1	<ul style="list-style-type: none"><li>Disinfect the skin overlying the abscess/bubo with 70% isopropyl alcohol.</li></ul>
2	<ul style="list-style-type: none"><li>Aspirate the fluid from the abscess with a sterile needle and syringe. Only enough fluid to perform the diagnostic tests is required.</li></ul>
3	<ul style="list-style-type: none"><li>Transfer the aspirate aseptically into a sterile tube with transport medium.</li></ul>
4	<ul style="list-style-type: none"><li>Gently ease off crust with a lancet or scalpel and a pair of disposable forceps</li></ul>

### IV. Skin biopsy

Skin biopsies from live patients are generally not appropriate specimens for field outbreak investigations. For details of the collection of skin biopsies after death for suspected viral hemorrhagic fevers, see the relevant section in Annex 9, Post-mortem specimen collection.

#### HANDLING AND TRANSPORT

Specimens for bacteriological analysis should be transported in Stuart's or Amies medium. Swabs for suspected viral pathogens should be transported in virus transport medium. Other specimens should be handled as described in the relevant section.

If processing takes longer than 2 hours, bacteriology specimens can be maintained at ambient temperature for 24 hours. Specimens for virus isolation may be refrigerated at 4-8°C, and transported to the laboratory as rapidly as possible. In some instances, the outbreak investigation team may bring liquid nitrogen for specimen preservation. If this is the case, follow the instructions of the experienced laboratorian as to appropriate use. If there are any questions regarding handling and transport, check with the laboratory which will be receiving the specimens. In any outbreak investigation, it should be considered essential to consult the receiving laboratory about the handling of most specimen types before setting out into the field.



# CARPHA Laboratory Procedure Manual

Section: QSE 05 – Process Control

Title: Laboratory User Manual

Doc. No: GUL-Q05-001

Page 39 of 58

Effective date: 01.07.2013

Review date: 01.07.2014

Edition: 1

## G. COLLECTION OF URINE SAMPLES

### MATERIALS

SUPPLIES	REAGENTS
<ul style="list-style-type: none"> <li>• Sterile plastic cup with lid (50ml or more)</li> <li>• Clean, screw-top specimen transport containers (“universal” containers are often used)</li> <li>• Gauze pads</li> </ul>	<ul style="list-style-type: none"> <li>• Soap and clean water (or normal saline) if possible</li> </ul>

### PROCEDURE

#### *Collection of Mid-Stream Urine (MSU) Sample*

STEP	ACTION
1	<ul style="list-style-type: none"> <li>• Give the patient clear instructions to pass urine for a few seconds, and then hold the cup in the urine stream for a few seconds to catch a mid-stream sample. This should decrease the risk of contamination from organisms living in the urethra</li> </ul>
2	<ul style="list-style-type: none"> <li>• To decrease the risk of contamination from skin organisms, the patient should be directed to avoid touching the inside rim of the plastic cup with the skin of the hands, legs or external genitalia.</li> <li>• Tighten the cap firmly when finished.</li> </ul>
3	<ul style="list-style-type: none"> <li>• For hospitalized or debilitated patients, it may be necessary to wash the external genitalia with soapy water to reduce the risk of contamination. If soap and clean water are not available, the area may be rinsed with normal saline.</li> <li>• Dry the area thoroughly with gauze pads before collecting the urine.</li> </ul>
4	<ul style="list-style-type: none"> <li>• Urine collection bags may be necessary for infants. If used, transfer urine from the urine bag to specimen containers as soon as possible to prevent contamination with skin bacteria. Use a disposable transfer pipette to transfer the urine.</li> </ul>
5	<ul style="list-style-type: none"> <li>• Label the specimen containers</li> </ul>



**CARPHA Laboratory Procedure Manual**

Section: QSE 05 – Process Control

Title: Laboratory User Manual

Doc. No: GUL-Q05-001

Page 40 of 58

Effective date: 01.07.2013

Review date: 01.07.2014

Edition: 1

***Processing Urine for Viral Isolation***

STEP	ACTION
1	<ul style="list-style-type: none"><li>Centrifuge the specimen at 1,500 rpm for 5 min.</li></ul>
2	<ul style="list-style-type: none"><li>Re-suspend the sediment in 0.5 to 2ml of viral transport media</li></ul>
3	<ul style="list-style-type: none"><li>Label the vial with patient's name type of specimen and date of collection.</li></ul>
4	<ul style="list-style-type: none"><li>Refrigerate at 4-8 °C and send as soon as possible to CARPHA or store at -70°C if shipping is delayed.</li></ul>

**HANDLING AND TRANSPORT**

- Transport to the laboratory within 2-3 hours of collection. If this is not possible, do not freeze but keep the specimen refrigerated at 4-8°C.
- Keeping the specimen refrigerated will decrease the risk of overgrowth of contaminating organisms
- Ensure that transport containers are leak-proof and tightly sealed.



# CARPHA Laboratory Procedure Manual

Section: QSE 05 – Process Control

Title: Laboratory User Manual

Doc. No: GUL-Q05-001

Page 41 of 58

Effective date: 01.07.2013

Review date: 01.07.2014

Edition: 1

## H. COLLECTION OF POSTMORTEM TISSUE SAMPLES

### MATERIALS

SUPPLIES	REAGENTS
<ul style="list-style-type: none"> <li>Barrier precautions: double gloves, sterile gown, eye goggles, mask</li> <li>Aseptic surgical and biopsy instruments for collecting tissue specimens.</li> <li>Sterile containers, sterile screw cap tubes or vials and slide box.</li> </ul>	<ul style="list-style-type: none"> <li>Fixatives: saline, appropriate viral and bacterial transport media.</li> <li>Disinfectant such as household bleach 1:10.</li> </ul>

**For collecting blood and other fluids, refer to corresponding annex for materials.**

### PROCEDURE

STEP	ACTION
1	<ul style="list-style-type: none"> <li>Use a separate sterile instrument for each tissue specimen from affected sites (several fragments with 1-2 grams of each is sufficient).</li> <li>Smaller, but adequate, specimens are taken with a biopsy needle.</li> </ul>
2	<ul style="list-style-type: none"> <li>Place difference tissues in separate sterile containers containing the relevant medium:               <ul style="list-style-type: none"> <li>- Fixatives for histopathology,</li> <li>- Sterile saline for preparation of tissues for immunofluorescence microscopy</li> <li>- Microbiological transport media for the isolation of bacterial and viral pathogens.</li> </ul> </li> </ul>
3	<ul style="list-style-type: none"> <li>Label all containers and tighten the screw caps firmly.</li> </ul>

- Other specimens are collected as per the relevant annex.
- Blood may be taken from the heart cavities.
- If cerebral malaria is suspected, make several smears from the cerebral cortex on glass slides to detect *Plasmodium falciparum*. Label the slides and transport in a slide box.



# CARPHA Laboratory Procedure Manual

Section: QSE 05 – Process Control

Title: Laboratory User Manual

Doc. No: GUL-Q05-001

Page 42 of 58

Effective date: 01.07.2013

Review date: 01.07.2014

Edition: 1

## HANDLING AND TRANSPORT

- Fixed specimens can be stored at ambient temperatures
- Tissue specimens for isolation of bacterial pathogens can be transported at ambient temperature in transport media for up to 24 hours.
- Transport tissue specimens for isolation of viral pathogens in viral transport medium or sterile saline at 4-8°C for 24-48 hours. For longer periods, freeze and store at -70°C.
- If rabies is suspected and brain samples are collected, freeze unfixed specimens immediately after collection. Formalin fixed samples are also useful and may be transported at ambient temperature.

### H.2.0 Post- Mortem Skin Biopsy

#### MATERIALS

SUPPLIES	REAGENTS
<ul style="list-style-type: none"> <li>• Instruments: Punch biopsy tool or scissors and forceps</li> </ul>	<ul style="list-style-type: none"> <li>• Screw-cap vial containing sterile saline.</li> </ul>

#### PROCEDURE

STEP	ACTION
1	<ul style="list-style-type: none"> <li>• Take out a vial containing the sterile saline. Lay out the instruments</li> </ul>
2	<p><b>Using a punch-biopsy tool</b></p> <ul style="list-style-type: none"> <li>• Place the open, sharp end on the skin and swivel into the skin, pressing firmly.</li> <li>• Remove the tool from the skin and lift the biopsy specimen out with forceps.</li> <li>• Cut free with scalpel or scissors.</li> </ul> <p><b>Using a scissors to take the biopsy</b></p> <ul style="list-style-type: none"> <li>• Lift the skin to be sampled with forceps.</li> <li>• Cut a small piece of skin from the area.</li> <li>• Use the forceps to remove the skin specimen.</li> </ul>
3	<ul style="list-style-type: none"> <li>• Place the specimen in a vial containing the sterile saline, and close the screw cap tightly</li> </ul>
4	<ul style="list-style-type: none"> <li>• Label the specimen vial</li> </ul>
5	<ul style="list-style-type: none"> <li>• Discard all instruments safely – do not re-use.</li> </ul>



# CARPHA Laboratory Procedure Manual

Section: QSE 05 – Process Control

Title: Laboratory User Manual

Doc. No: GUL-Q05-001

Page 43 of 58

Effective date: 01.07.2013

Review date: 01.07.2014

Edition: 1

In the diagnosis of rabies, samples from the nape of the neck at the hairline are preferred as concentrations of virus are likely to be high

## Post-mortem skin biopsy for diagnosis of pathogens with high infectious risks (e.g. viral haemorrhagic fever)

### MATERIALS

- All these materials are assembled in one kit.
- For bio-safety reasons the protective clothing and gloves are for one-time use only, and should be incinerated after use.

SUPPLIES	REAGENTS
<ul style="list-style-type: none"> <li>• Bucket, soap and water</li> <li>• Gown, latex gloves, heavy duty rubber gloves, plastic apron.</li> <li>• Masks and, where available, respirators for aerosol protection.</li> <li>• Instruments: punch biopsy tool or scissors, forceps</li> </ul>	<ul style="list-style-type: none"> <li>• Screw-cap vial containing 10% buffered formalin fixative.</li> <li>• Disinfection solution.</li> </ul>

### PROCEDURE

STEP	ACTION
1	<ul style="list-style-type: none"> <li>• Put on protective clothing beginning with gown followed by latex gloves, rubber gloves, facial mask, and plastic apron.</li> </ul>
2	<ul style="list-style-type: none"> <li>• Open the vial containing the formalin fixative. Lay out the instruments.</li> </ul>
3	<ul style="list-style-type: none"> <li>• Gently turn the head of the cadaver to expose the nape of the neck. This area is selected because it is less visible and is highly vascular</li> </ul>
4	<p><b><i>Using a punch-biopsy tool</i></b></p> <ul style="list-style-type: none"> <li>• Place the open, sharp end on the skin and swivel into the skin, pressing firmly.</li> <li>• Remove the tool from the skin and lift the biopsy specimen out with forceps.</li> <li>• Cut free with scalpel or scissors.</li> </ul> <p><b><i>Using a scissors to take the biopsy</i></b></p>
5	<ul style="list-style-type: none"> <li>• Place the specimen in the vial containing the formalin fixative, and close the screw cap tightly.</li> <li>• Dip the closed vial in the disinfectant for 1 minute and allow to dry.</li> </ul>



**CARPHA Laboratory Procedure Manual**

**Section: QSE 05 – Process Control**

**Title: Laboratory User Manual**

**Doc. No: GUL-Q05-001**

**Page 44 of 58**

**Effective date: 01.07.2013**

**Review date: 01.07.2014**

**Edition: 1**

<b>STEP</b>	<b>ACTION</b>
<b>6</b>	<ul style="list-style-type: none"><li>• Drop the instruments in the disinfectant.</li><li>• When finished, remove the outer rubber gloves and drop them in the disinfectant.</li><li>• Keep the latex gloves on while removing materials from the disinfectant.</li></ul>
<b>7</b>	<ul style="list-style-type: none"><li>• Dispose of all protective clothing, rubber and latex gloves, and materials in a plastic bag and incinerate everything.</li></ul>
<b>8</b>	<ul style="list-style-type: none"><li>• Wash your hands well and disinfect with 70% isopropyl alcohol or povidone iodine</li></ul>
<b>9</b>	<ul style="list-style-type: none"><li>• Label the specimen vial.</li></ul>
<b>10</b>	<ul style="list-style-type: none"><li>• Pack the specimen vial and ship at ambient temperature.</li></ul>

Once the sample has been fixed in formalin, the decontaminated vial may be safely transported to the receiving laboratory.

**CARPHA Laboratory Procedure Manual**

Section: QSE 05 – Process Control

Title: Laboratory User Manual

Doc. No: GUL-Q05-001

Page 45 of 58

Effective date: 01.07.2013

Review date: 01.07.2014

Edition: 1

**I. COLLECTION OF TB SAMPLES**

CARPHA performs a PCR assay using the Xpert MTB/RIF test (for use with the Cepheid GeneXpert® System). This is a semi-quantitative nested real-time PCR *in-vitro* diagnostic test for:

- 1) the detection of *Mycobacterium tuberculosis* complex DNA in sputum samples or concentrated sediments prepared from induced or expectorated sputa that are either acid-fast bacilli (AFB) smear positive or negative; and
- 2) the detection of rifampin resistance associated mutations of the *rpoB* gene in samples from patients at risk for rifampin resistance.

The MTB/RIF test is intended for use with specimens from untreated patients for whom there is clinical suspicion of tuberculosis (TB). Use of Xpert MTB/RIF for detection of *M. tuberculosis* (MTB) or determination of rifampin susceptibility has not been validated for patients who are receiving treatment for tuberculosis.

STEP	ACTION
1	<ul style="list-style-type: none"> <li>• Select a sample container.</li> </ul>
2	<ul style="list-style-type: none"> <li>• Instruct the patient to rinse his or her mouth with plain water twice before bringing up the sputum.</li> </ul>
3	<ul style="list-style-type: none"> <li>• Open the lid of the sample container.</li> </ul>
4	<ul style="list-style-type: none"> <li>• Have the patient inhale deeply 2-3 times.</li> <li>• Cough deeply from the chest, and then spit into the sputum container by bringing it closer to the mouth.</li> <li>• Care should be taken to avoid spoiling or soiling the outside of the container.</li> <li>• Secure the lid on the collection device.</li> </ul>
5	<ul style="list-style-type: none"> <li>• Make sure the sputum sample is of good quality.</li> <li>• Check the sample for food particles, blood or substances that may inhibit PCR process.</li> <li>• The sample volume should be at least 1ml.</li> </ul>

**HANDLING AND TRANSPORT**

- **Treat all sputum samples as potentially infectious material and use leak proof containers for sample collection and transportation.**
- Specimens should be held at 2°C- 8°C (The sample remains viable at this temperature for 4-10 days.)
- Transport the sample to CARPHA at (2°C- 8°C)



## CARPHA Laboratory Procedure Manual

Section: QSE 05 – Process Control

Title: Laboratory User Manual

Doc. No: GUL-Q05-001

Page 46 of 58

Effective date: 01.07.2013

Review date: 01.07.2014

Edition: 1

### ANNEX 3

## GUIDELINES FOR PREPARATION, PACKING AND SHIPPING SPECIMENS

### Shipper's Responsibilities for Preparation of Accompanying Documentation

- Use the proper form/s
- Fill out the form/s accurately, completely and legibly
- Comply with carriers' requirements for filling out the form/s (handwritten vs. typed)
- Sign the form/s (signature must be handwritten)
- Modifications and alterations must be signed by the shipper (best practice is to complete a new form if a correction is needed)
- The form/s must be printed in color on white paper (e.g. for the Dangerous Goods Declaration Form the left and right diagonal striations must be printed in red)
- The form must be completed in English
- The shipper must complete **three copies**. One copy is for the shipper and the remaining two are for the operator



## CARPHA Laboratory Procedure Manual

Section: QSE 05 – Process Control

Title: Laboratory User Manual

Doc. No: GUL-Q05-001

Page 47 of 58

Effective date: 01.07.2013

Review date: 01.07.2014

Edition: 1

### 1. Categorization of Infectious Substances

- There are four (4) Classes of Dangerous Goods which are relevant to a certified shipper of infectious substances –
  - a) Class 2: Non-flammable, non-toxic gases
    - Division 2.2 Refrigerated liquid Nitrogen used for refrigeration
  - b) Class 3: Flammable liquids (e.g. Ethanol used for preservation)
  - c) Class 6: Toxic and Infectious Substances
    - Division 6.1 Toxic substances
    - *Division 6.2. Infectious substances(Category A and Category B)*
  - d) Class 9: Miscellaneous Dangerous Goods (e.g. dry ice)

There are two substance categories which fall **under Division 6.2. Infectious Substances**

- I. **Category A, Infectious Substances:** is an infectious substance which is transported in a form, that if an exposure occurs, it is capable of causing permanent disability, life-threatening or fatal disease in otherwise healthy humans or animals
- II. **Category B:** is an infectious substance which does not meet the criteria for inclusion in Category A

### 2. United Nations (UN) Numbers and Proper shipping names –

#### ➤ Category A , Infectious Substances

**UN 2814, Proper Shipping Name: *Infectious Substance, Affecting Humans***-assigned to *infectious substances meeting the above criteria which cause disease in humans or both in humans and animals*

**UN 2900, Proper Shipping Name: *Infectious Substance, Affecting Animals only*** - assigned to infectious substances which can cause disease in animals only.

**NOTE:** Assignment to UN 2814 or UN 2900 shall be based on the known medical history and symptoms of the source human or animal, endemic local conditions, or professional judgement concerning individual circumstances of the source: human or animal.

#### ➤ Category B, Infectious Substances

**UN 3373, Proper Shipping Name: Biological Substance**



**CARPHA Laboratory Procedure Manual**

Section: QSE 05 – Process Control

Title: Laboratory User Manual

Doc. No: GUL-Q05-001

Page 48 of 58

Effective date: 01.07.2013

Review date: 01.07.2014

Edition: 1

**Table 1: Examples of Infectious Substances included in Category A**

(Reference: Annex 2 WHO Guidance on regulations for the Transport of Infectious Substances 2011-2012)

UN Number and Proper Shipping Name	Microorganism
<b>UN 2814 Infectious substance, affecting humans</b>	<i>Bacillus anthracis</i> (cultures only) <i>Brucella abortus</i> (cultures only) <i>Brucella melitensis</i> (cultures only) <i>Brucella suis</i> (cultures only) <i>Burkholderia mallei</i> – <i>Pseudomonas mallei</i> – glanders (cultures only) <i>Burkholderia pseudomallei</i> – <i>Pseudomonas pseudomallei</i> (cultures only) <i>Chlamydia psittaci</i> – avian strains (cultures only) <i>Clostridium botulinum</i> (cultures only) <i>Coccidioides immitis</i> (cultures only) <i>Coxiella burnetii</i> (cultures only) Crimean-Congo haemorrhagic fever virus Dengue virus (cultures only) Eastern equine encephalitis virus (cultures only) <i>Escherichia coli, verotoxigenic</i> (cultures only) Ebola virus Flexal virus <i>Francisella tularensis</i> (cultures only) Guanarito virus Hantaan virus Hantaviruses causing haemorrhagic fever with renal syndrome Hendra virus Hepatitis B virus (cultures only) Herpes B virus (cultures only) Human immunodeficiency virus (cultures only) Highly pathogenic avian influenza virus (cultures only) Japanese Encephalitis virus (cultures only) Junin virus Kysanur Forest disease virus Lassa virus Machupo virus Marburg virus Monkeypox virus <i>Mycobacterium tuberculosis</i> (cultures only) Nipah virus Omsk haemorrhagic fever virus Poliovirus (cultures only)

**CARPHA Laboratory Procedure Manual**

Section: QSE 05 – Process Control

Title: Laboratory User Manual

Doc. No: GUL-Q05-001

Page 49 of 58

Effective date: 01.07.2013

Review date: 01.07.2014

Edition: 1

UN Number and Proper Shipping Name	Microorganism
<b>UN 2814 Infectious substance, affecting humans</b>	Rabies virus (cultures only) <i>Rickettsia prowazekii</i> (cultures only) <i>Rickettsia rickettsii</i> (cultures only) Rift Valley fever virus (cultures only) Russian spring-summer encephalitis virus (cultures only) Sabia virus <i>Shigella dysenteriae type 1</i> (cultures only) <sup>1</sup> Tick-borne encephalitis virus (cultures only) Variola virus Venezuelan equine encephalitis virus (cultures only) West Nile virus (cultures only) Yellow fever virus (cultures only) <i>Yersinia pestis</i> (cultures only)
<b>UN 2900 Infectious substance, affecting animals only</b>	African swine fever virus (cultures only) Avian paramyxovirus Type 1 – Velogenic Newcastle disease virus (cultures only) Classical swine fever virus (cultures only) Foot and mouth disease virus (cultures only) Lumpy skin disease virus (cultures only) <i>Mycoplasma mycoides</i> – contagious bovine pleuropneumonia (cultures only) Peste des petits ruminants virus (cultures only) Rinderpest virus (cultures only) Sheep-pox virus (cultures only) Goatpox virus (cultures only) Swine vesicular disease virus (cultures only) Vesicular stomatitis virus (cultures only)

**NOTE:** The table above ((Reference: Annex 2 WHO Guidance on regulations for the Transport of Infectious Substances 2011-2012) is not exhaustive. Infectious substances, including new or emerging pathogens, which do not appear in the table but which meet the same criteria shall be assigned to Category A. In addition, if there is doubt as to whether or not a substance meets the criteria it shall be included in Category A.



## CARPHA Laboratory Procedure Manual

Section: QSE 05 – Process Control

Title: Laboratory User Manual

Doc. No: GUL-Q05-001

Page 50 of 58

Effective date: 01.07.2013

Review date: 01.07.2014

Edition: 1

## 2. Packaging and Shipping Instructions

Shippers of infectious substances shall ensure that packages are prepared utilizing the **Triple Packaging System**. This packaging system is used for the transportation of all infectious substances in such a manner that they reach their destination in good condition and present no hazard to persons or animals during transport.

As the name suggests, there are **three layers of containment** to protect the substances being shipped –

- **Primary receptacle** containing the specimen must be leak-proof and watertight. It is wrapped/ packaged with sufficient absorbent material to absorb all fluid in case of breakage.
- **Secondary packaging** is a second durable, watertight, leak-proof container/receptacle used to enclose and protect the primary receptacle(s). Several cushioned primary receptacles may all be placed in one secondary packaging ensuring sufficient additional absorbent material is used to absorb all fluid in case of breakage.
- **Outer packaging** involves placing secondary packaging in outer shipping packaging with suitable cushioning material.

### I. Shipping Category A Infectious Substances

Infectious substances which fall under Category A can only be transported in packaging which meets the **UN Class 6.2 specifications** and in accordance with **Packaging Instruction (PI) 620**. (See PI 620 below)

This ensures stipulated performance criteria are met such as a 9 m drop test, puncture test, pressure test and stacking test. The outer packaging must bear the UN specification marking which indicates that the packaging has passed the performance tests to the satisfaction of the competent authority.



**CARPHA Laboratory Procedure Manual**

**Section: QSE 05 – Process Control**

**Title: Laboratory User Manual**

**Doc. No: GUL-Q05-001**

**Page 51 of 58**

**Effective date: 01.07.2013**

**Review date: 01.07.2014**

**Edition: 1**

**TABLE 2: Requirements for Packaging and Shipping Category A Substances**

<b>PACKAGING REQUIREMENTS</b>	<b>MARKINGS AND LABELS</b>	<b>DOCUMENTATION</b>
<ul style="list-style-type: none"> <li>• Primary container is leakproof</li> <li>• Secondary container is leakproof</li> <li>• Outer container is rigid</li> <li>• UN specification marking: Pressure tested at 95kPa Drop tested from 9m Puncture tested at 7kg Stacking tested</li> <li>• <b>Shipper must be trained</b></li> </ul>	<p><b>Markings –</b></p> <ul style="list-style-type: none"> <li>• Shipper’s name and address</li> <li>• Receiver’s name and address</li> <li>• Name and telephone of responsible person (who is available 24 hours a day until shipment arrives)</li> <li>• Proper Shipping Name and UN Number</li> <li>• UN Specification Marking</li> </ul> <p><b>Labels –</b></p> <ul style="list-style-type: none"> <li>• Infectious substance label</li> <li>• Package orientation label (<i>only used when primary container exceeds 50ml</i>)</li> </ul>	<ul style="list-style-type: none"> <li>• Airway Bill</li> <li>• Dangerous Goods Declaration Form</li> </ul> <p><b>Must be signed by the shipper</b></p> <ul style="list-style-type: none"> <li>• <b>Import/Export permit (as applicable)</b></li> <li>• CARICOM Invoice</li> </ul>

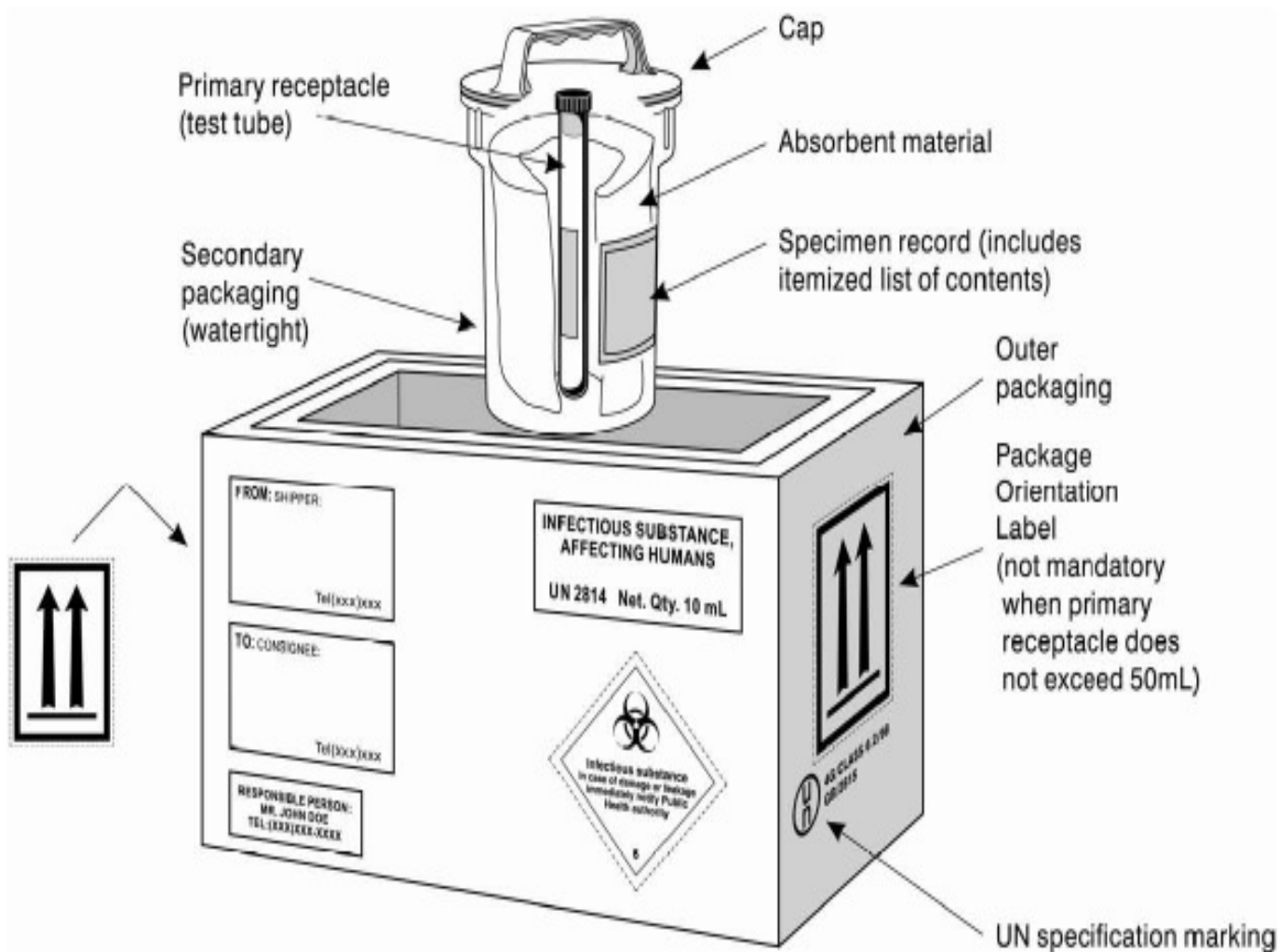

**Example of Triple Packaging System for the packaging and labeling of Category A, Infectious Substance (Reference WHO Guidance on regulations for the Transport of Infectious Substances 2011-2012)**



**CARPHA Laboratory Procedure Manual**

**Section: QSE 05 – Process Control**

**Title: Laboratory User Manual**

**Doc. No: GUL-Q05-001**

**Page 53 of 58**

**Effective date: 01.07.2013**

**Review date: 01.07.2014**

**Edition: 1**

**II. Shipping Category B Infectious Substances**

The triple packaging system continues to apply, including for local surface transport. However, testing documents are not required and it may be possible to source packaging locally rather than finding an authorized supplier, provided that the packaging manufacturer and the shipper can comply fully with the requirements of **Packaging Instruction PI 650**.

**TABLE 3: Requirements for Packaging and Shipping Category B Substances**

<b>Packaging Requirements</b>	<b>Markings and Labels</b>	<b>Documentation</b>
<ul style="list-style-type: none"> <li>• Primary container is leakproof</li> <li>• Secondary container is leakproof</li> <li>• Outer container is rigid</li> <li>• Either Primary or Secondary container is Pressure tested at 95kPa</li> <li>• Drop tested from 1.2 m</li> </ul>	<p><b>Markings –</b></p> <ul style="list-style-type: none"> <li>• Shipper’s name and address</li> <li>• Receiver’s name and address</li> <li>• Proper Shipping Name and UN Number</li> </ul> <p><b>Labels –</b></p> <ul style="list-style-type: none"> <li>• None required (unless shipping with Dry Ice)</li> </ul>	<ul style="list-style-type: none"> <li>• Airway Bill</li> <li>• CARICOM Invoice</li> <li>• <b>Import/Export permit (as applicable)</b></li> </ul> <p><i>Note: Dangerous Goods Declaration Form is not required, even when shipping with Dry Ice</i></p>

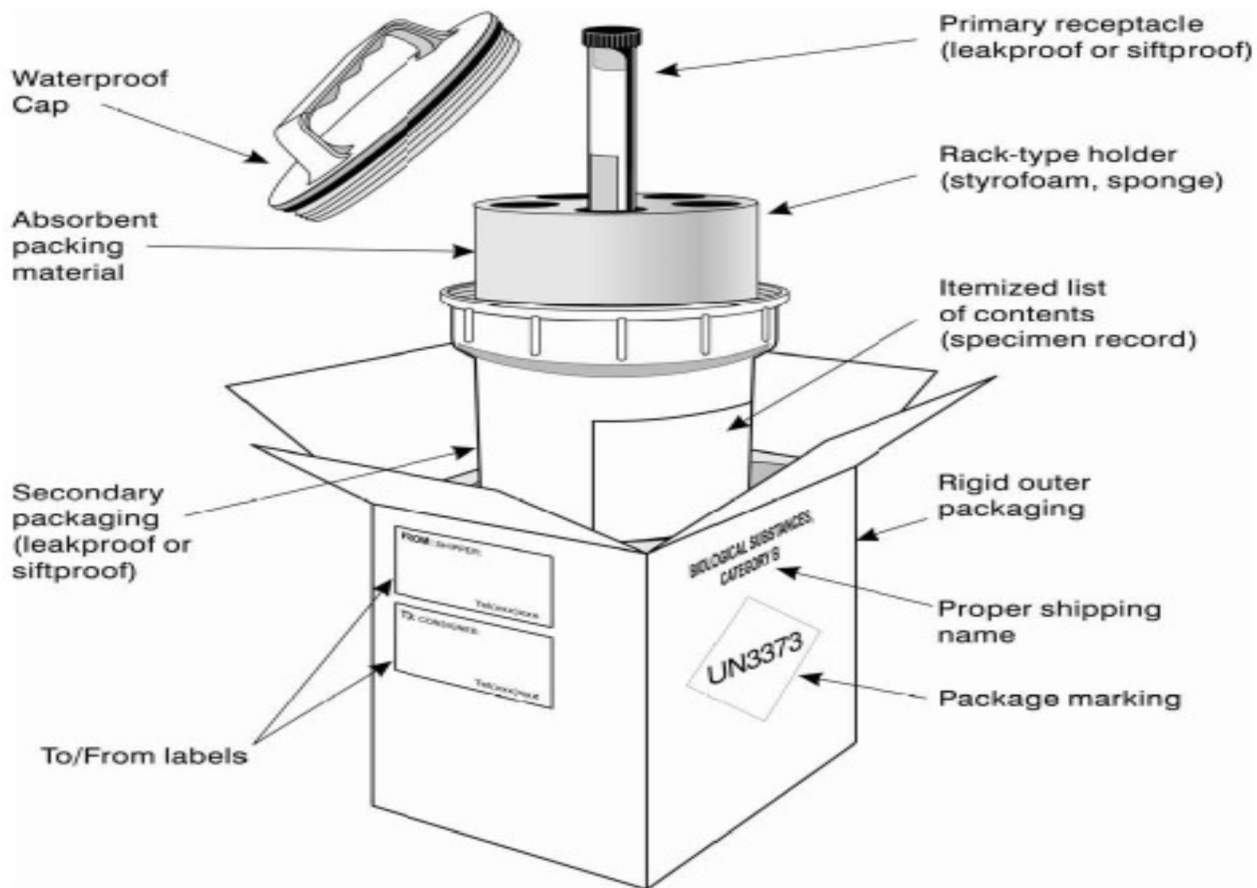

Figure 2: Example of Triple Packaging System for the packaging and labeling of Category B, Infectious Substance



**CARPHA Laboratory Procedure Manual**

**Section: QSE 05 – Process Control**

**Title: Laboratory User Manual**

**Doc. No: GUL-Q05-001**

**Page 55 of 58**

**Effective date: 01.07.2013**

**Review date: 01.07.2014**

**Edition: 1**

**Other: Shipping Exempt Substances**

Human or animal specimens (patient specimens) for which there is minimal likelihood that pathogens are present are not subject to these Regulation if the specimen is transported in a packaging which will prevent any leakage and which is marked with the words “Exempt human specimen” or “Exempt animal specimen”, as appropriate.

NOTE: An element of professional judgment is required to determine if a substance is exempt. That judgment should be based on the known medical history, symptoms and individual circumstances of the source, human or animal, and endemic local conditions.

**TABLE 4: Requirements for Packaging and Shipping Exempt Substances**

<b>Packaging Requirements</b>	<b>Markings and Labels</b>	<b>Documentation</b>
<ul style="list-style-type: none"> <li>• Primary container is leak-proof</li> <li>• Secondary container is leak-proof</li> <li>• Outer container is of adequate strength for its capacity, mass and intended use, and with at least one surface having minimum dimensions of 100 mm × 100 m</li> </ul>	<p><b>Markings –</b></p> <ul style="list-style-type: none"> <li>• Shipper’s name and address</li> <li>• Receiver’s name and address</li> <li>• Package marked with “Exempt human specimen” or “Exempt animal specimen” as applicable</li> </ul> <p><b>Labels –</b></p> <p>None required (unless shipping with Dry Ice)</p>	<ul style="list-style-type: none"> <li>• Airway Bill</li> <li>• CARICOM Invoice</li> </ul> <p><i>Note: Dangerous Goods Declaration Form is not required, even when shipping with Dry Ice</i></p>





## CARPHA Laboratory Procedure Manual

Section: QSE 05 – Process Control

Title: Laboratory User Manual

Doc. No: GUL-Q05-001

Page 56 of 58

Effective date: 01.07.2013

Review date: 01.07.2014

Edition: 1

### Other: Limitations for shipments by Air

#### ➤ Weight and volume (excluding overpacks)

- **Category A Substances**

Maximum 50ml or 50g per package for passenger aircraft

Maximum 4kg or 4l per package for cargo aircraft

- **Category B Substances**

Maximum 4kg or 4l per package for passenger or cargo aircraft

Maximum 1l per primary container for passenger or cargo aircraft

#### ➤ Multiple samples

Multiple primary containers can be placed in the same package and must be individually wrapped or separated to prevent contact

#### ➤ Package dimensions

- **PI620 packages:** the smallest external dimension shall not be less than 10cm

- **PI650 packages:** at least one surface of the outer packaging must have a minimal dimension of 10cm x 10cm

#### ➤ Use of Dry Ice as a Refrigerant

Dry ice shall be placed outside the secondary receptacle and must not be placed inside the primary or secondary receptacle because of the risk of explosions.

A specially designed insulated packaging may be used to contain dry ice. The packaging must permit the release of carbon dioxide gas if dry ice is used.

**Packing instruction P003 (ICAO/IATA PI954) shall be observed.**

The secondary receptacle shall be secured within the outer package to maintain the original orientation of the inner packages after the refrigerant has dissipated.

If dry ice is used to ship infectious substances in **Category A**, the details shall appear on the shipper's **Declaration for Dangerous Goods**.

**In addition, the outermost packaging shall carry the hazard label for dry ice and the appropriate marking.**

If dry ice is used to ship **Category B Infectious Substances** or **Exempt Specimens**, the package shall be marked “Carbon dioxide, solid” or “Dry ice”.

The airway bill must indicate the proper name (Dry Ice), class (Class 9), UN number (UN 1845) and weight (in kg).

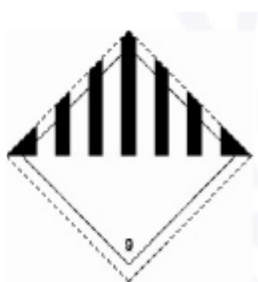

Dry Ice Label

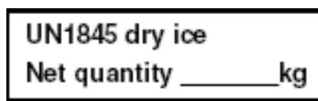

Dry Ice Marking

**Figure 3 Dry Ice label and marking to be placed on the outer packaging**