



Version A	Revision and compilation notes Issued with report	Date 23.10.2009	Client Caribbean Environmental Health Institute			
			Project Antigua and Barbuda Rainwater Harvesting for Groundwater Recharge			
 <p>Upton House Market Street, Charlbury Oxfordshire OX7 3PJ United Kingdom</p> <p>tel +44 (0)1608 810374 fax +44 (0)1608 810093 e-mail info@gwp.uk.com web www.gwp.uk.com</p>			Example of rainwater harvesting tank and overflow to small soakaway			
		Date 23.10.2009	Drawn JS/LS	Checked CC	Scale NTS	
GWP Consultants LLP. Registered No. OC326183. Registered Office: Upton House, Market Street, Charlbury, Oxfordshire OX7 3PJ, UK			Drawing Ref ANTAGWR0909		Drawing No 1	Version A

A: Infiltration trench with surface inflow (for good quality run-off)



B: Infiltration trench with perforated pipe and capacity for pre-treatment

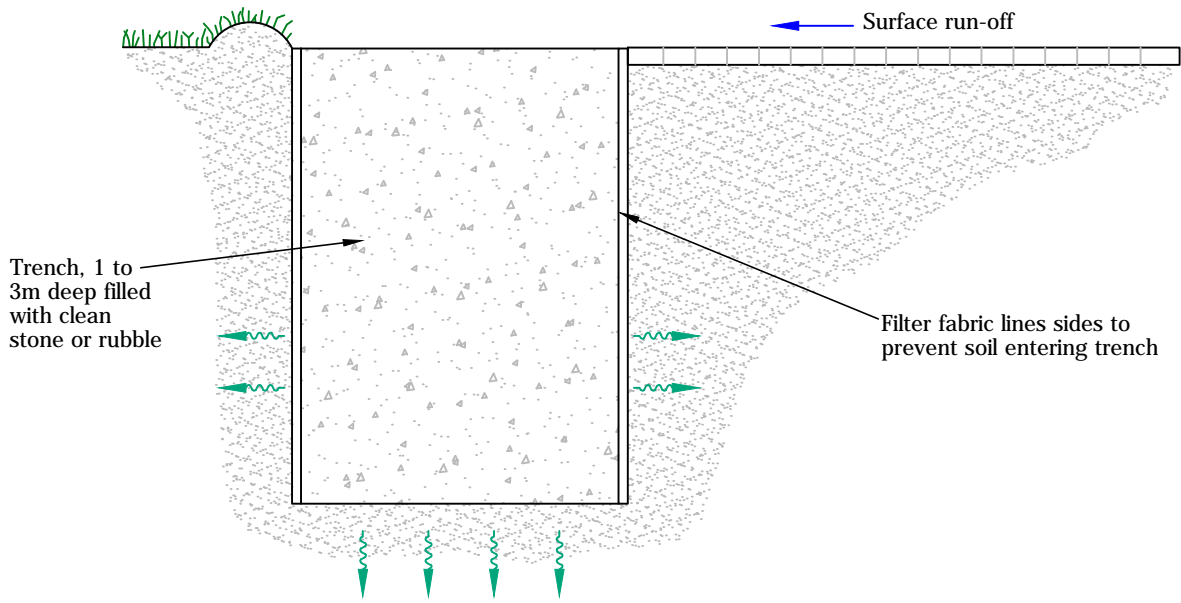
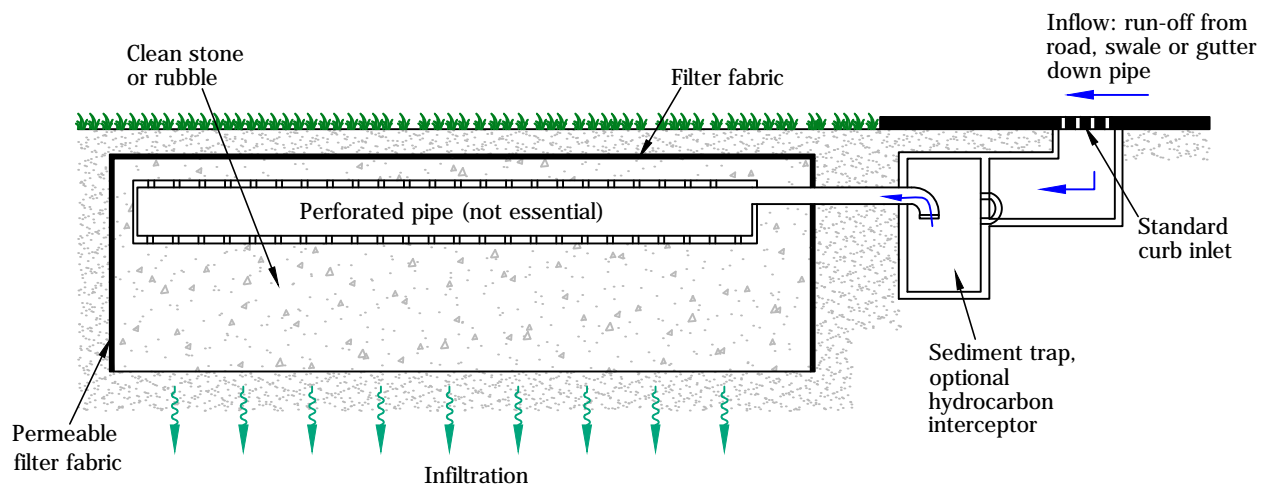

Version A	Revision and compilation notes Issued with report	Date 23.10.2009	Client Caribbean Environmental Health Institute			
			Project Antigua and Barbuda Rainwater Harvesting for Groundwater Recharge			
			Examples of infiltration trenches			
		Date 23.10.2009	Drawn JS/LS	Checked CC	Scale NTS	
			Drawing Ref ANTAGWR0909		Drawing No 2	Version A

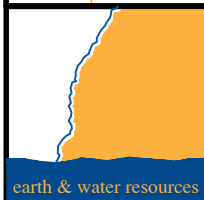

GWP consultants

Upton House
Market Street, Charlbury
Oxfordshire OX7 3PJ
United Kingdom

tel +44 (0)1608 810374
fax +44 (0)1608 810093
e-mail info@gwp.uk.com
web www.gwp.uk.com

GWP Consultants LLP, Registered No. OC326183.
Registered Office: Upton House, Market Street, Charlbury, Oxfordshire OX7 3PJ, UK

Top View

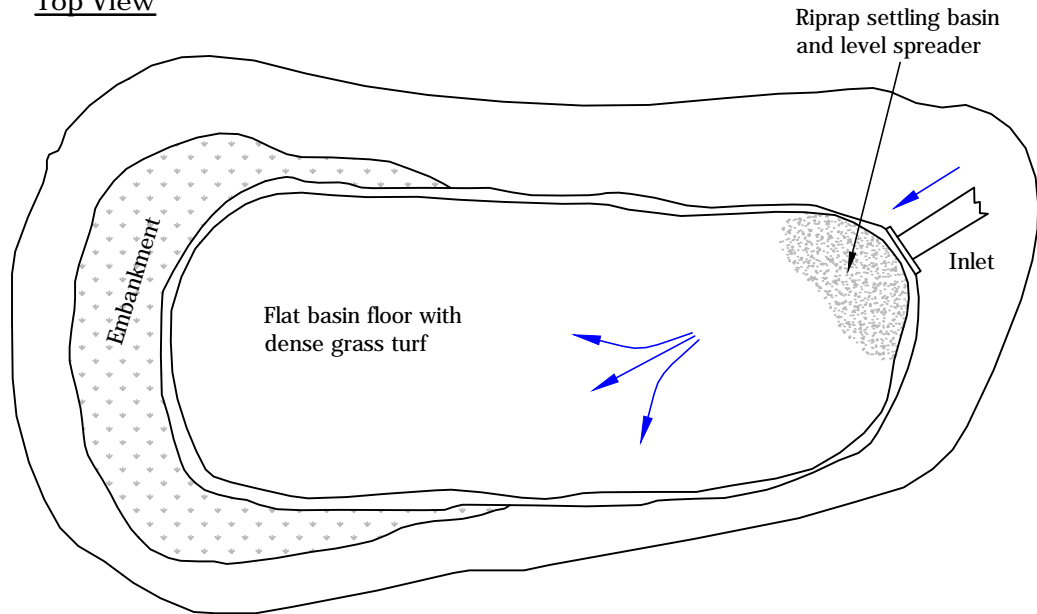

Side View

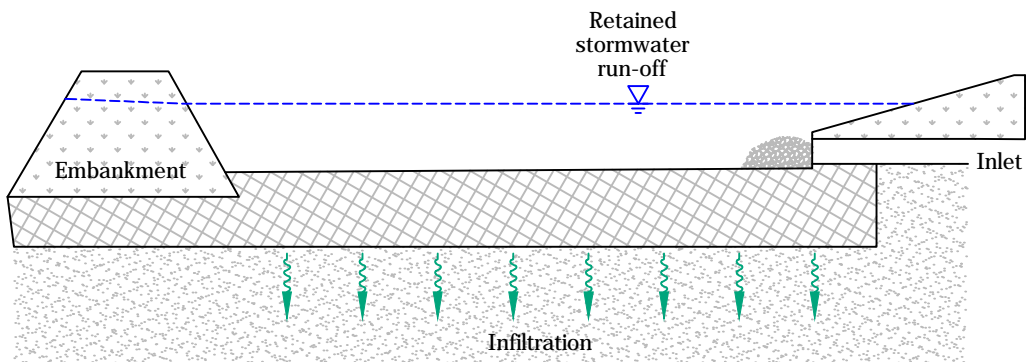

<p>Version A</p>	<p>Revision and compilation notes Issued with report</p>	<p>Date 23.10.2009</p>	<p>Client Caribbean Environmental Health Institute</p>			
			<p>Project Antigua and Barbuda Rainwater Harvesting for Groundwater Recharge</p>			
 <p>GWP consultants Upton House Market Street, Charlbury Oxfordshire OX7 3PJ United Kingdom tel +44 (0)1608 810374 fax +44 (0)1608 810093 e-mail info@gwp.uk.com web www.gwp.uk.com</p>			<p>Example of an infiltration basin for storm run-off</p>			
<p>Date 23.10.2009</p>		<p>Drawn JS/LS</p>	<p>Checked CC</p>	<p>Scale NTS</p>		
<p>Drawing Ref ANTAGWR0909</p>			<p>Drawing No 3</p>	<p>Version A</p>		

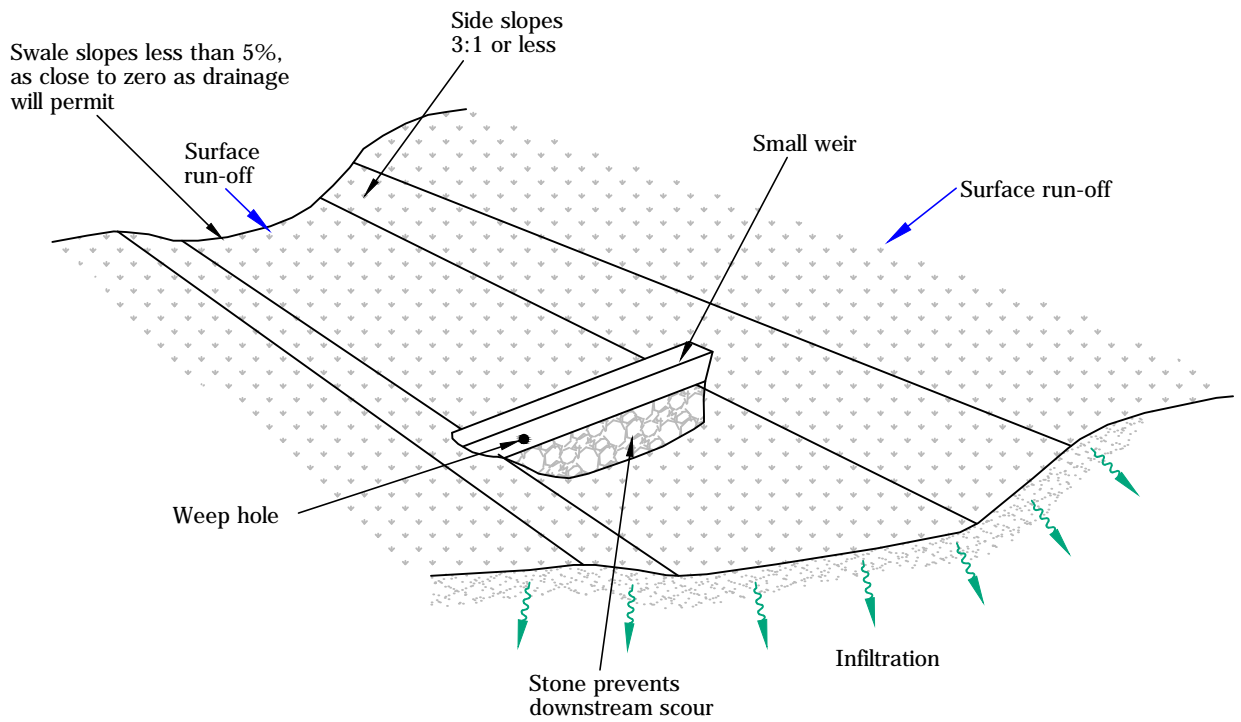

Version A	Revision and compilation notes Issued with report	Date 23.10.2009	Client Caribbean Environmental Health Institute				
			Project Antigua and Barbuda Rainwater Harvesting for Groundwater Recharge				
 <p data-bbox="478 1960 869 2027">GWP consultants</p> <p data-bbox="478 2027 869 2094">Upton House Market Street, Charlbury Oxfordshire OX7 3PJ United Kingdom</p> <p data-bbox="686 2027 869 2094">tel +44 (0)1608 810374 fax +44 (0)1608 810093 e-mail info@gwp.uk.com web www.gwp.uk.com</p> <p data-bbox="478 2105 869 2141"><small>GWP Consultants LLP. Registered No. OC326183. Registered Office: Upton House, Market Street, Charlbury, Oxfordshire OX7 3PJ, UK</small></p>			Example of a grassed swale				
			Date 23.10.2009	Drawn JS/LS	Checked CC	Scale NTS	
			Drawing Ref ANTAGWR0909		Drawing No 4	Version A	

A: Recharge well or 'suckwell' for storm drainage

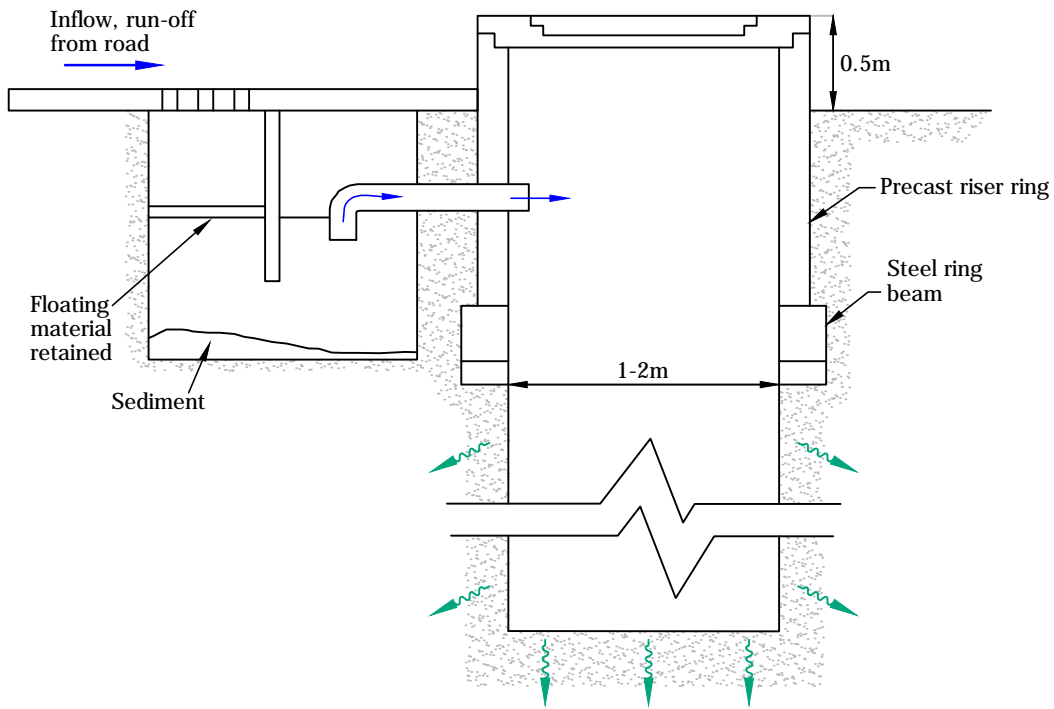

B: Recharge well or 'suckwell' to enhance infiltration in a basin

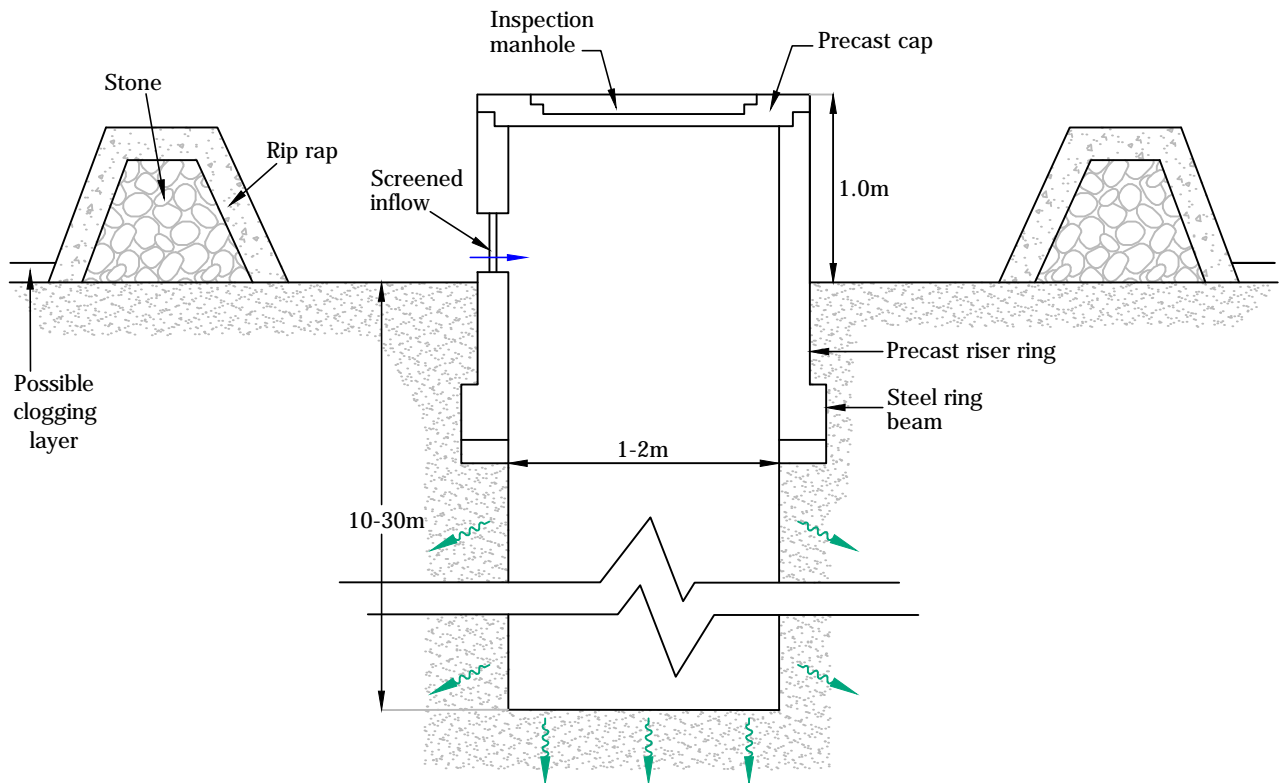

Version A	Revision and compilation notes Issued with report	Date 23.10.2009	Client Caribbean Environmental Health Institute				
			Project Antigua and Barbuda Rainwater Harvesting for Groundwater Recharge				
			Examples of recharge wells				
Date 23.10.2009		Drawn JS/LS		Checked CC		Scale NTS	
Drawing Ref ANTAGWR0909			Drawing No 5		Version A		

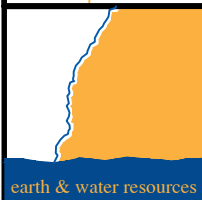

GWP consultants

Upton House
Market Street, Charlbury
Oxfordshire OX7 3PJ
United Kingdom
tel +44 (0)1608 810374
fax +44 (0)1608 810093
e-mail info@gwp.uk.com
web www.gwp.uk.com

GWP Consultants LLP. Registered No. OC326183.
Registered Office: Upton House, Market Street, Charlbury, Oxfordshire OX7 3PJ, UK

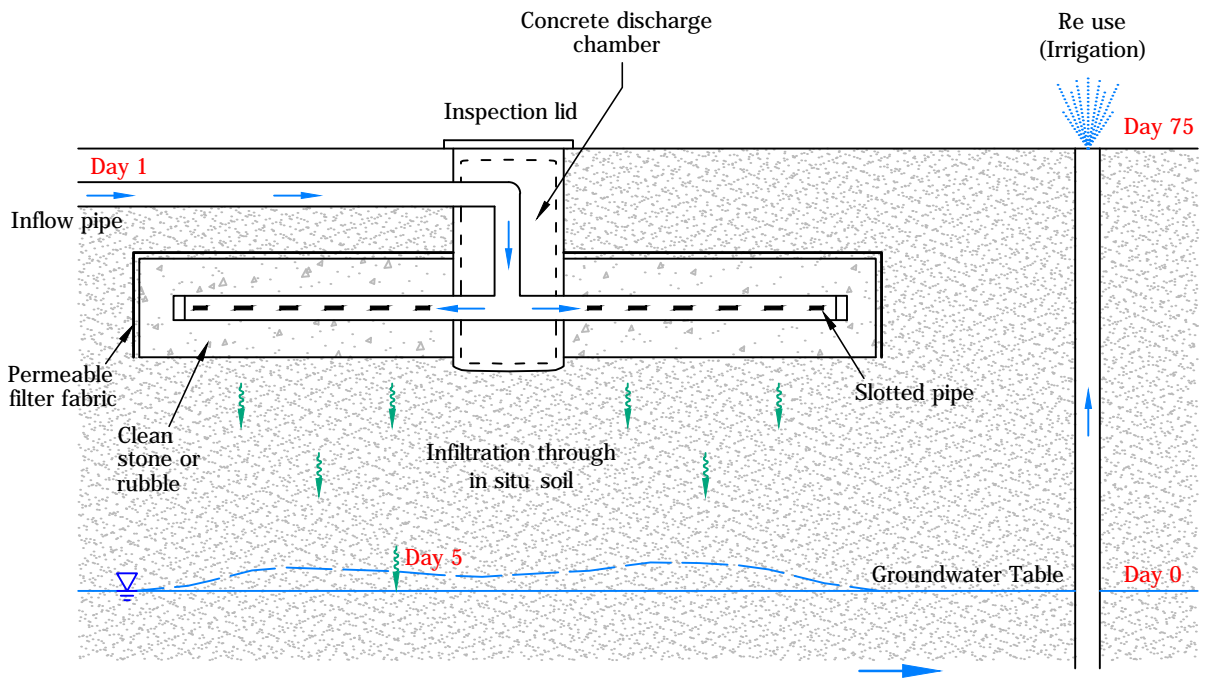

Version A	Revision and compilation notes Issued with report	Date 23.10.2009	Client Caribbean Environmental Health Institute			
			Project Antigua and Barbuda Rainwater Harvesting for Groundwater Recharge			
			Example of infiltration gallery to recharge treated waste water			
		Date 23.10.2009	Drawn JS/EMB	Checked CC	Scale NTS	
		Drawing Ref ANTAGWR0909		Drawing No 6		Version A



GWP consultants

Upton House
Market Street, Charlbury
Oxfordshire OX7 3PJ
United Kingdom

tel +44 (0)1608 810374
fax +44 (0)1608 810093
e-mail info@gwp.uk.com
web www.gwp.uk.com

GWP Consultants LLP. Registered No. OC326183.
Registered Office: Upton House, Market Street, Charlbury, Oxfordshire OX7 3PJ, UK

Plan

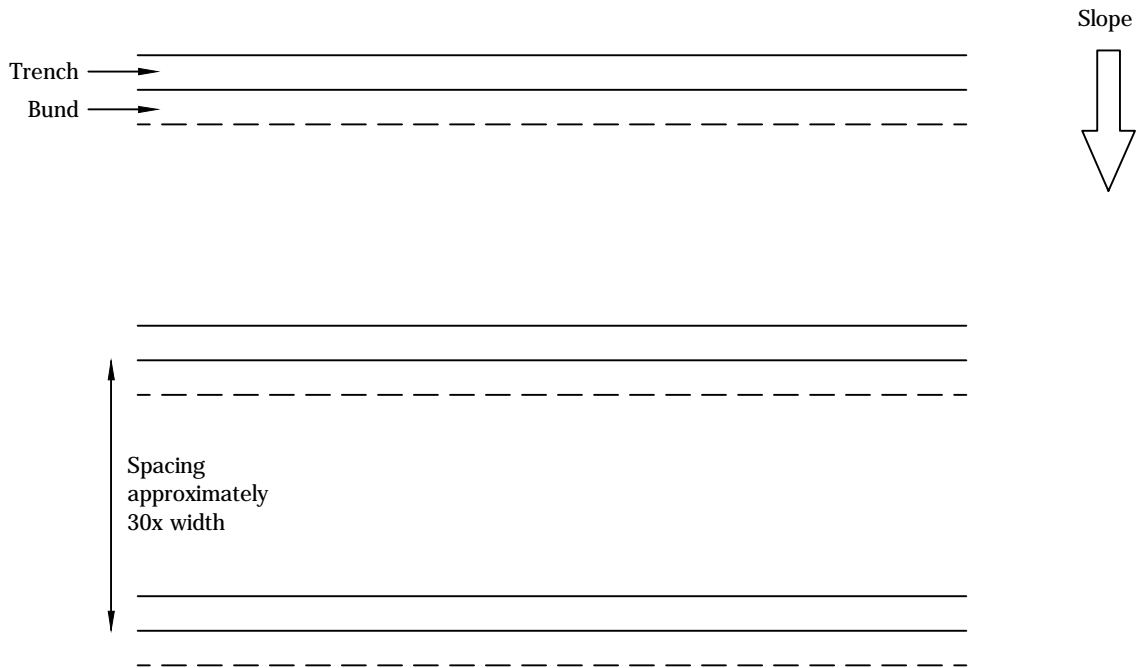

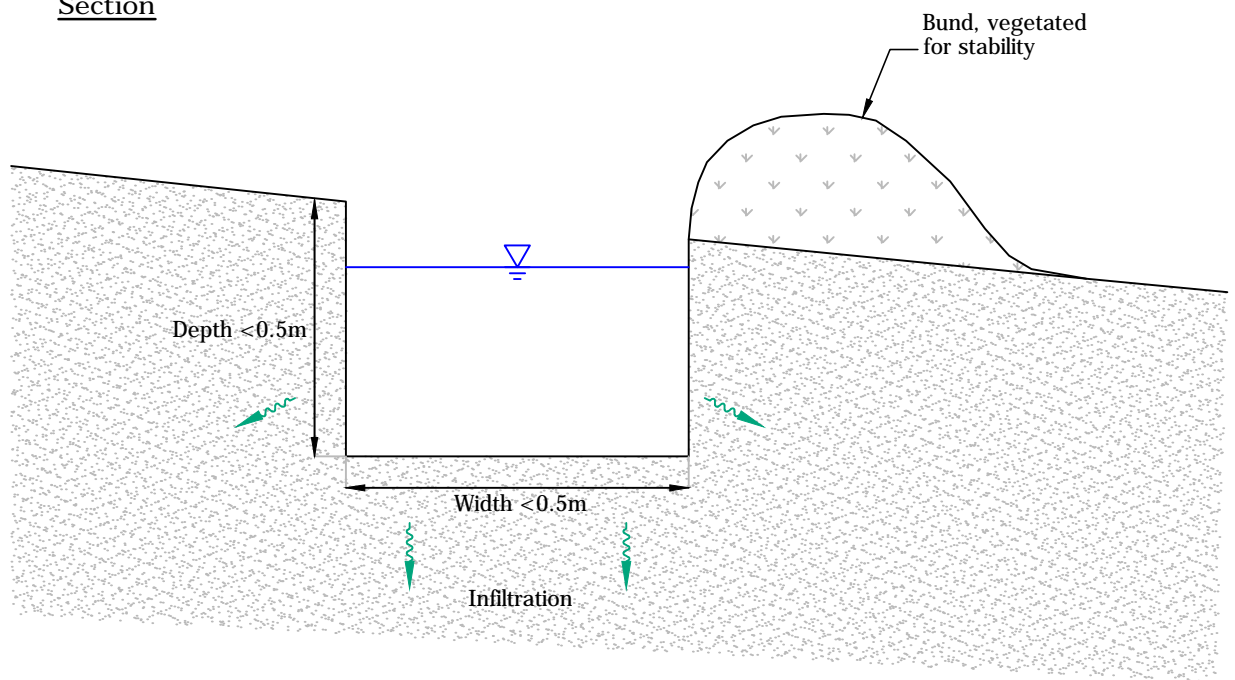

Section

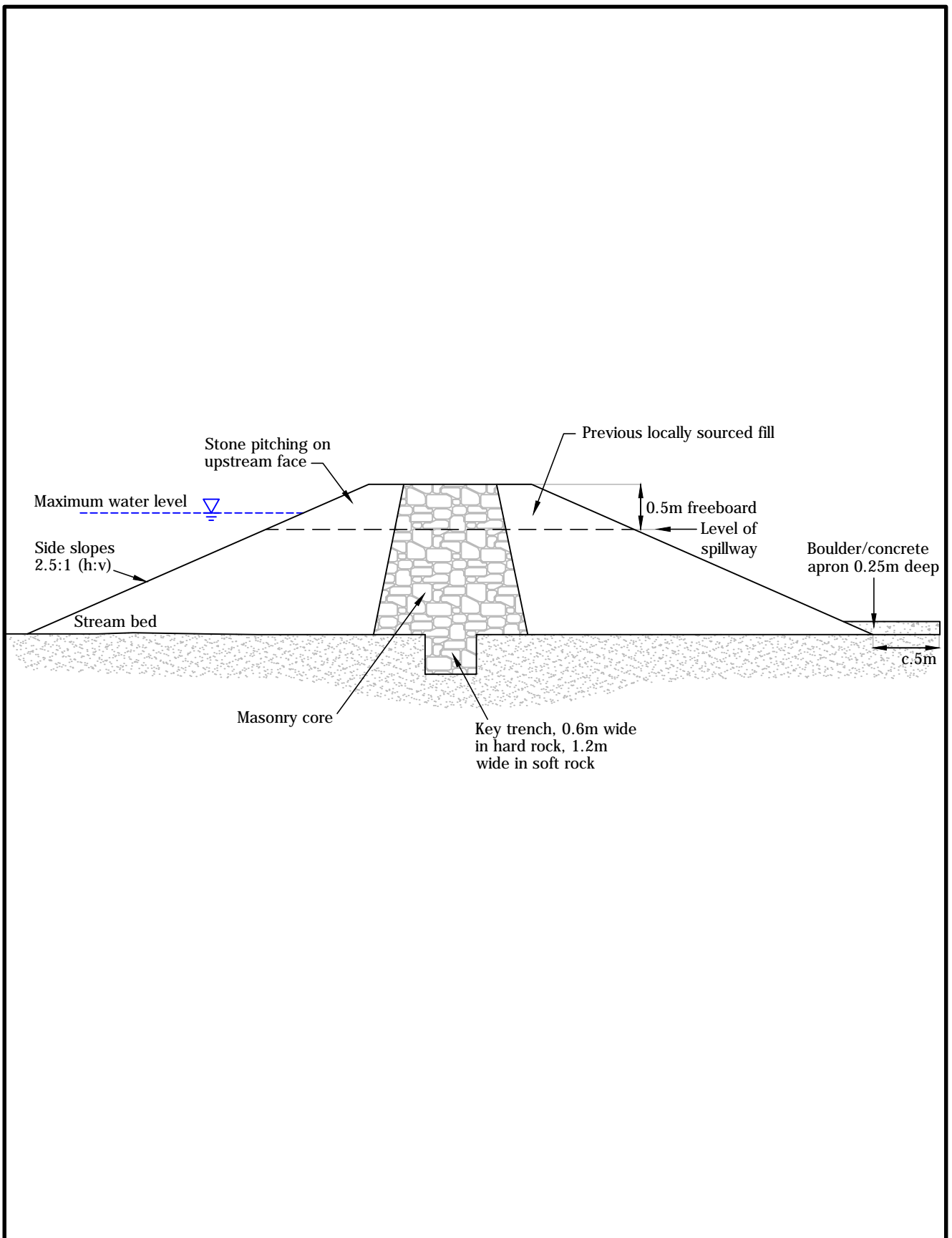

Version A	Revision and compilation notes Issued with report	Date 23.10.2009	Client Caribbean Environmental Health Institute				
			Project Antigua and Barbuda Rainwater Harvesting for Groundwater Recharge				
 <p>GWP consultants Upton House Market Street, Charlbury Oxfordshire OX7 3PJ United Kingdom tel +44 (0)1608 810374 fax +44 (0)1608 810093 e-mail info@gwp.uk.com web www.gwp.uk.com</p> <p><small>GWP Consultants LLP. Registered No. OC326183. Registered Office: Upton House, Market Street, Charlbury, Oxfordshire OX7 3PJ, UK</small></p>			Example layout of contour trenching with bunds				
			Date 23.10.2009	Drawn JS/LS	Checked CC	Scale NTS	
			Drawing Ref ANTAGWR0909		Drawing No 7	Version A	



Version A	Revision and compilation notes Issued with report	Date 23.10.2009	Client Caribbean Environmental Health Institute			
			Project Antigua and Barbuda Rainwater Harvesting for Groundwater Recharge			
			Example of an earth check dam with a masonry core			
		<p>GWP consultants</p> <p>Upton House Market Street, Charlbury Oxfordshire OX7 3PJ United Kingdom</p> <p>tel +44 (0)1608 810374 fax +44 (0)1608 810093 e-mail info@gwp.uk.com web www.gwp.uk.com</p>	Date 23.10.2009	Drawn JS/LS	Checked CC	Scale NTS
<p>GWP Consultants LLP. Registered No. OC326183. Registered Office: Upton House, Market Street, Charlbury, Oxfordshire OX7 3PJ, UK</p>			Drawing Ref ANTAGWR0909	Drawing No 8	Version A	

A: For small stream of relatively low sediment load

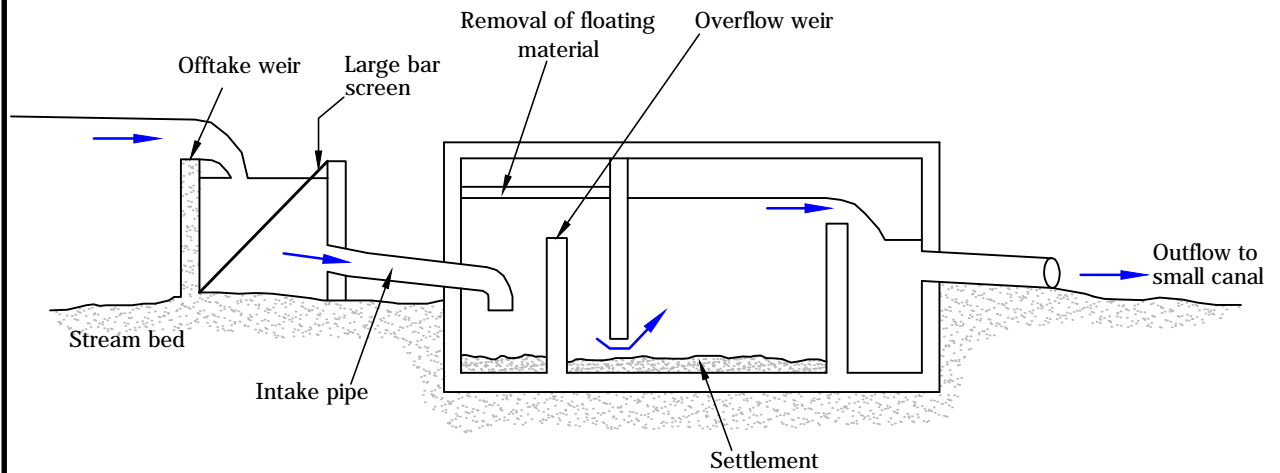

B: Diversion with earth bund across stream bed

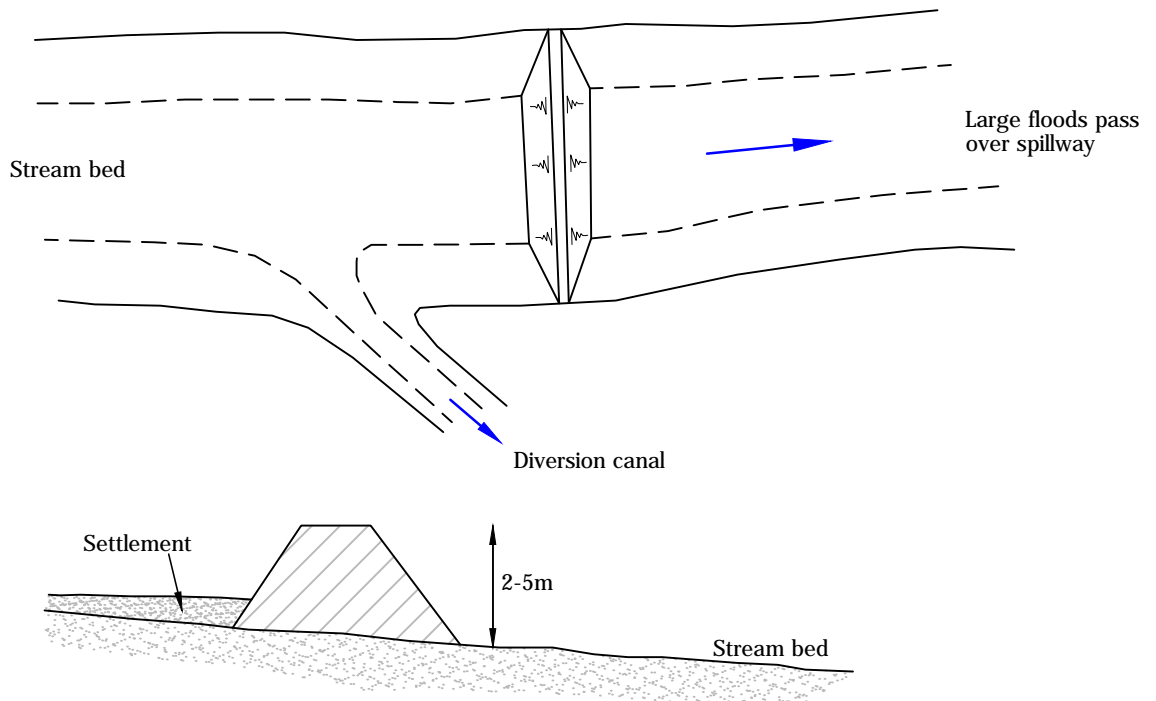

Version A	Revision and compilation notes Issued with report	Date 23.10.2009	Client Caribbean Environmental Health Institute				
			Project Antigua and Barbuda Rainwater Harvesting for Groundwater Recharge				
			Examples of simple stream offtake/diversion structures				
Date 23.10.2009		Drawn JS/LS		Checked CC		Scale NTS	
Drawing Ref ANTAGWR0909			Drawing No 9		Version A		



GWP consultants

Upton House
Market Street, Charlbury
Oxfordshire OX7 3PJ
United Kingdom

tel +44 (0)1608 810374
fax +44 (0)1608 810093
e-mail info@gwp.uk.com
web www.gwp.uk.com

GWP Consultants LLP, Registered No. OC326183.
Registered Office: Upton House, Market Street, Charlbury, Oxfordshire OX7 3PJ, UK

A: Infiltration basin with settlement pond

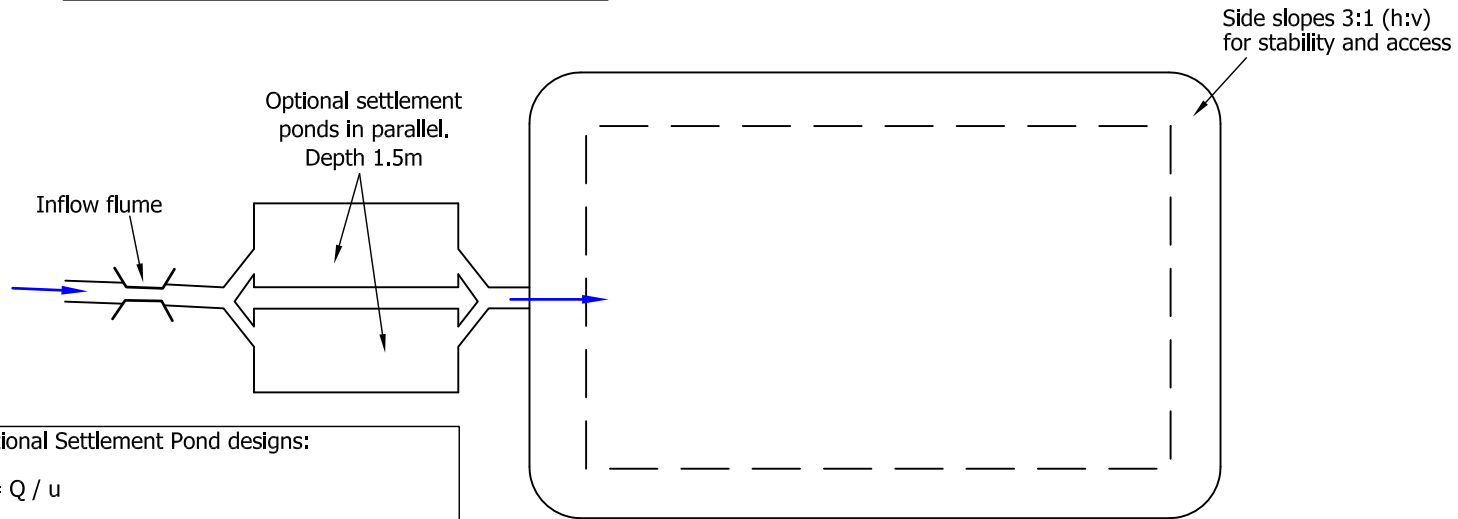

Optional Settlement Pond designs:
 $A = Q / u$
 where A = surface area; Q = discharge rate;
 u = settling velocity (depends on sediment type)

B: Ditch and furrow system

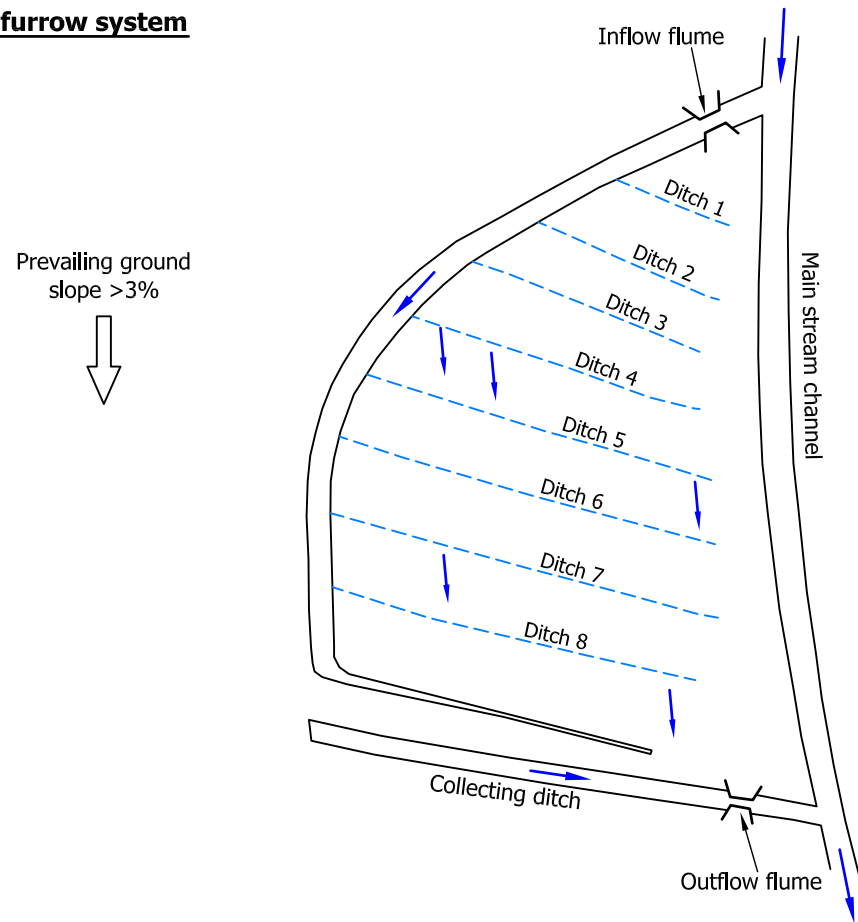

C: Controlled flooding

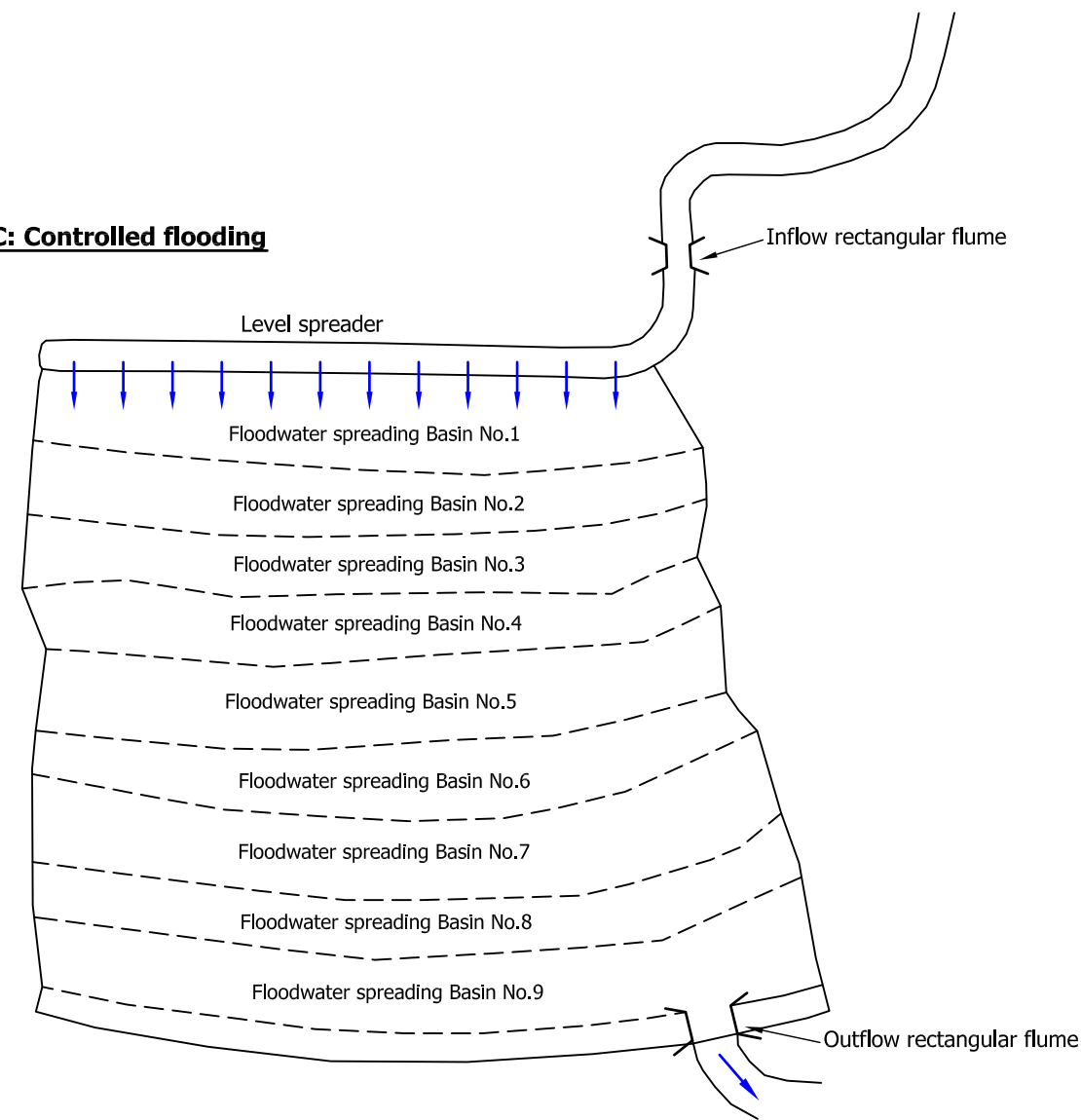

Version A	Revision and compilation notes Issued with report	Date 23.10.2009	Client Caribbean Environmental Health Institute		
			Project Antigua and Barbuda Rainwater Harvesting for Groundwater Recharge		
			Examples of offline infiltration systems		
Date 23.10.2009		Drawn JS/LS	Checked CC	Scale NTS	
Drawing Ref ANTAGWR0909			Drawing No 10	Version A	

GWP consultants
 Upton House
 Market Street, Charlbury
 Oxfordshire OX7 3PJ
 United Kingdom
 tel: +44 (0) 1608 810374
 fax: +44 (0) 1608 810093
 e-mail: info@gwp.uk.com
 web: www.gwp.uk.com

earth & water resources
 GWP Consultants LLP. Registered No. OC326183.
 Registered Office: Upton House, Market Street, Charlbury, Oxfordshire OX7 3PJ, UK